

User Manual

aSENSE MIII

CO₂ / CO sensor with built-in general purpose controller



Figure 1 aSENSE MIII for wall mounting and ventilation duct mounting

General

The IAQ-sensor product aSENSE MIII is used to measure indoor air carbon dioxide and carbon monoxide concentrations. It is a very flexible controller with programmable outputs for both relay- and linear control of e.g. mixed air dampers, humidifier and fans. The measured values are shown on the display.

The unit can alternatively be connected to common VAV (Variable Air Volume) controllers, or Direct Digital Control (DDC). The linear output functions are pre-programmed. All functions can be modified from a PC with the software UIP (version 4.3 or higher) and the RS232 communication cable.

FUNCTIONAL DESCRIPTION

aSENSE Mill is delivered pre-programmed (see description below). With the free software UIP4.3 (or later versions) and Senseair's standard communication cable for PC, A232 Cable, the user can adjust the product to his/hers application by, for example, changing the measurement ranges of the linear outputs, modify the set points of the alarm outputs, invert outputs and also reconfigure the functions and the logic that controls the outputs.

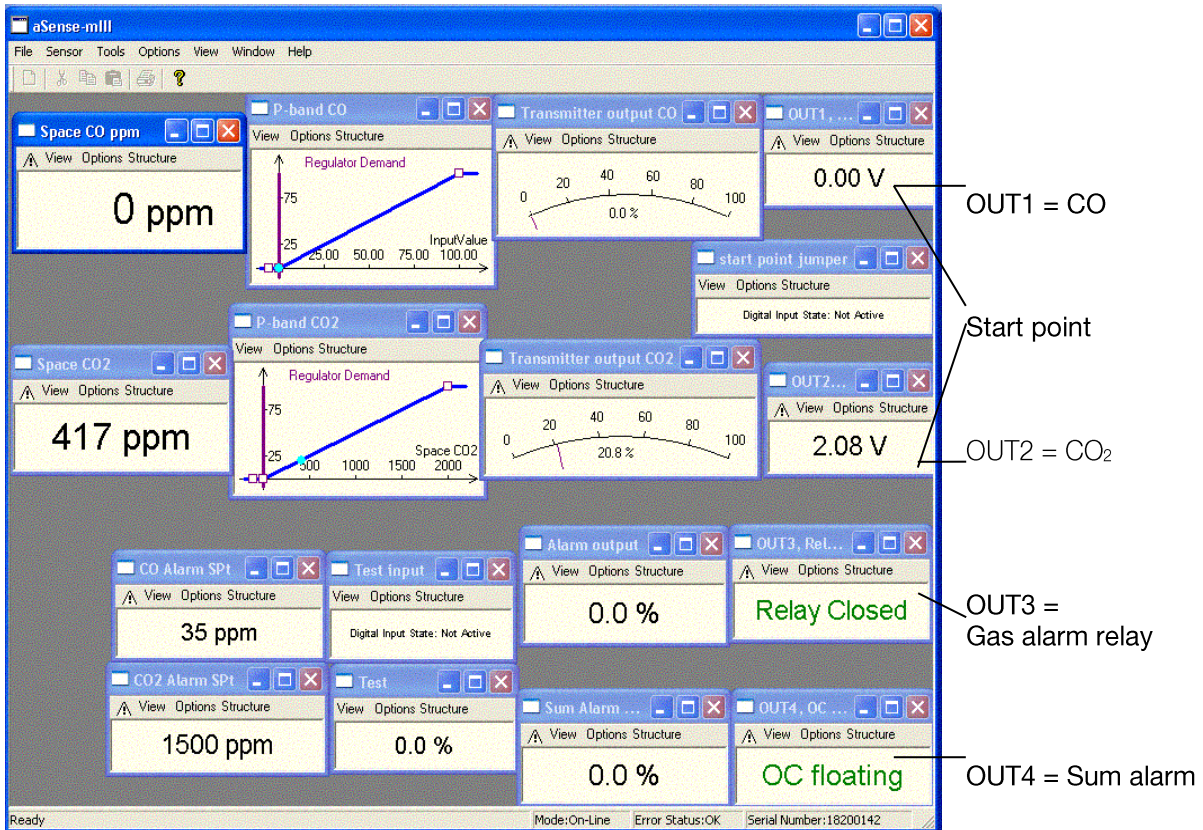

Figure 2 Print screen of UIP4.3 PC work space of aSENSE Mill where the pre-set functions can easily be redefined. The four outputs (far right) are here arranged in rows together with the function blocks that control the output.

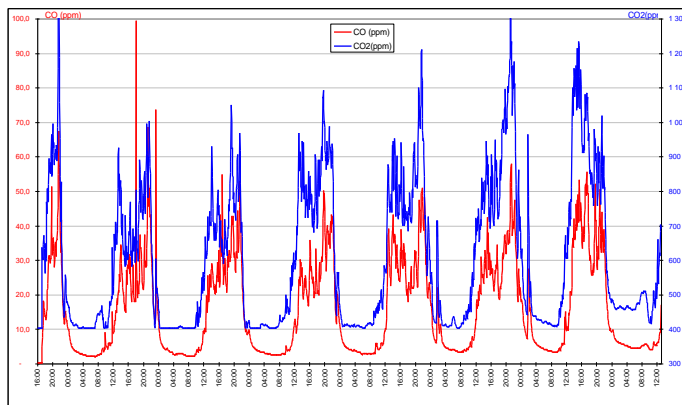

Figure 3 Recorded readings

Internal CO and CO₂ recorder samples data continuously every 20 minutes. After 13 days and 8 hours the storage memory is full and the oldest data are eventually overwritten one by one. The data storage is secured every four hours. In case of power failure the sampled data of the latest four hours at most will be lost. The other values can be studied with the software UIP4.3 and exported to a text file for further treatment in e.g. MS-EXCEL.

Standard configuration:

Out(1) is carbon monoxide output, Out(2) is carbon dioxide output and Out(3) is relay output. Out(4) is error status OR Out(3) is open.

Out(1) = measuring signal for carbon monoxide concentration

Out(2) = measuring signal for carbon dioxide concentration

Out(3) = ON/OFF of demand of air quality. The relay is open in alarm situations and at power loss. NOTE! There is a two minutes delay after start-up.

Out(4) = error status OR Out(3) open, carbon monoxide concentration > 35ppm OR carbon dioxide concentration > 1500ppm. There is a two minutes delay after start-up.

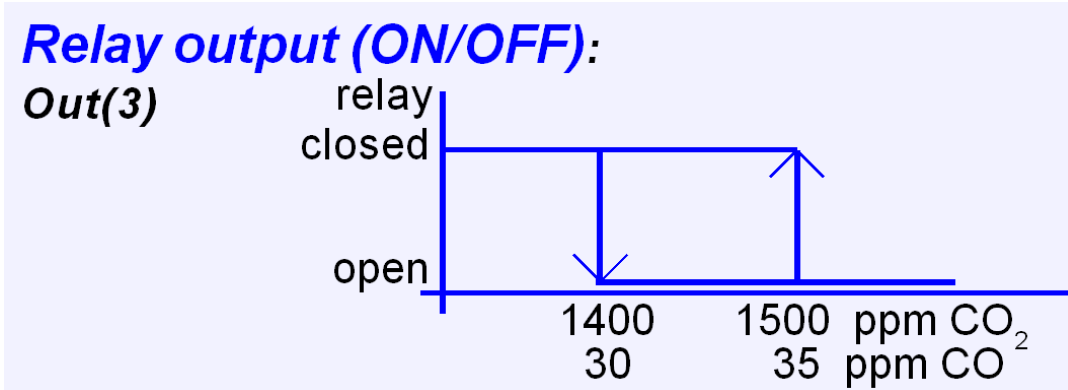

Figure 4 The control signal of air quality

# in figure 4	Terminal	Standard configuration	Standard settings	Standard function
1	~ +	Power (+)	24VAC/DC+ (+20%), 3W	2W without output load The same ground reference has to be used for the aSENSE MIII unit and for the control system!
2	⊥	Power ground (-)	24VAC/DC-	
3	Out(1)	0-10VDC	0-100ppm CO	Measuring signal carbon monoxide
4	Out(2)	0-10VDC	0-2000ppm CO ₂	Measuring signal carbon dioxide
5	Unmarked	Signal Ground (-)		Connected to G0 via PTC fuse
6	Relay			Air control Delay two minutes after start.
7		Closed	< 30ppm CO < 1400ppm CO ₂	The green LED is lit
		Open	> 35ppm CO > 1500ppm CO ₂	The relay is open in alarm situations and at power loss. The red LED is lit and the green is not lit.
8	Out(4) Open collector	Open	No error detected AND normal gas concentrations	Error status Delay two minutes after start.
		Closed	Error detected OR high gas concentrations	The red LED is lit if an error OR high gas concentrations are detected. If an error is detected also the yellow LED is lit

Table I. Default configuration of aSENSE MIII.

Output Configurations

A label on the inner side of the sensor lid shows the configuration of the outputs at the time of product delivery. The sensors/controllers are supplied from the factory (unless otherwise ordered) with 0...10VDC linear outputs for Out(1) and Out(2). Out(4) is an open collector output (see Table II). If different output configurations are needed for the application, these must be reconfigured before the unit is powered up. Default values are 0–10V.

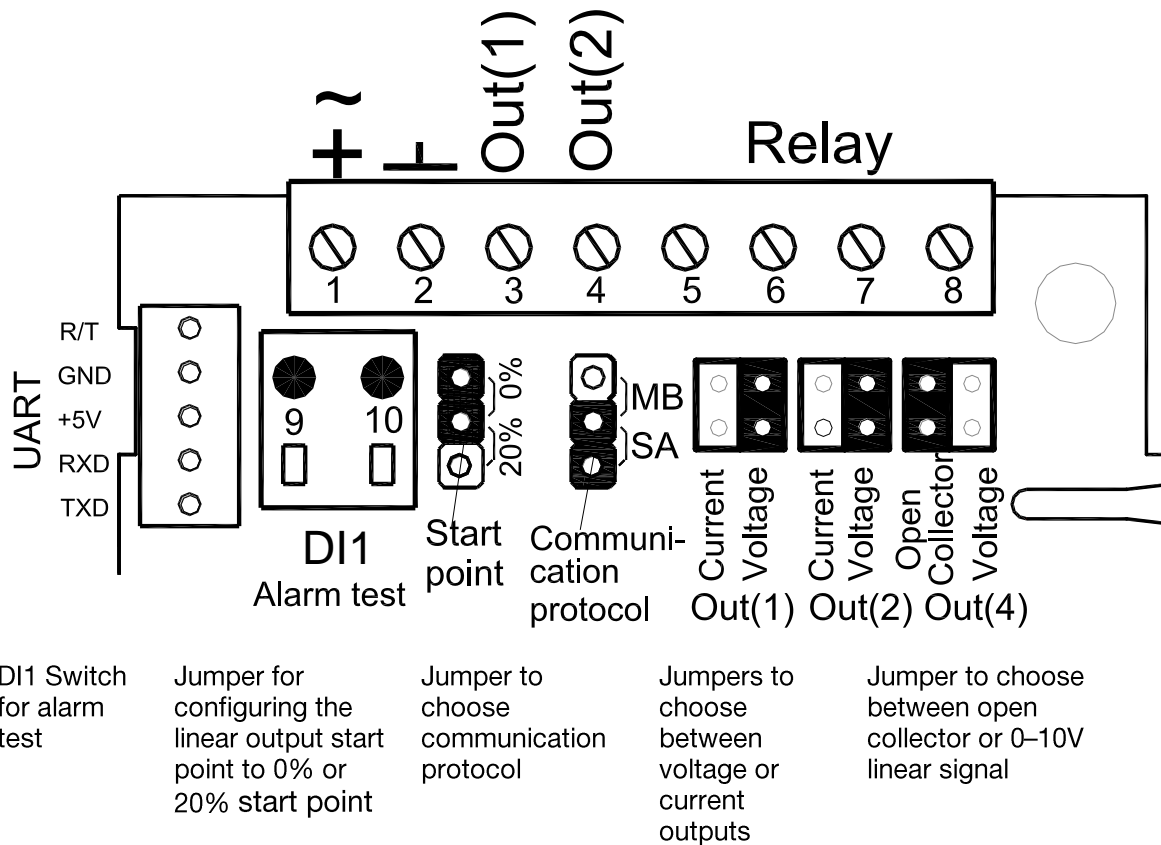

Figure 5 The connection terminal area of the aSENSE MIII with jumpers and terminals. The terminal DI1 may be used for forced ventilation. If the sensor has a heater it is connected to \sim and $-$.

Jumper	Position	Function
Start point selection jumper	0%	Jumper top position provides 0Vdc or 0mA start point for Out(1), Out(2) (0–20mA or 0–10V).
	20%	Jumper bottom position provides 2Vdc or 4mA start point for Out(1), Out(2) (4–20mA or 2–10V).
Communication selection jumper	MB	Modbus communication protocol
	SA	Senseair communication protocol
Out(1)	Current	Connection in position “Current” provides 0/4–20mA output range for Out(1).
	Voltage	Connection in position “Voltage” provides 0/2–10VDC output range for Out(1).
Out(2)	Current	Connection in position “Current” provides 0/4–20mA output range for Out(2).
	Voltage	Connection in position “Voltage” provides 0/2–10VDC output range for Out(2).
Out(4)	Voltage	Connection in position “Voltage” provides 0–10VDC for Out(4).
	Open collector	Connection in position “Open collector” provides an open collector output. Max 0.5A, 55VDC / 40VAC (half-wave rectifier).

Table II. Configuration jumpers for aSENSE MIII

Option - Network Adapter for Connection to RS-485-Network

The network adapter can be used to connect the Senseair sensor to a RS-485-network. The adapter is a small printed circuit board which can be used with all sensors with the housings large enough. The green LED flashes every time the adapter answers calls from the network master.

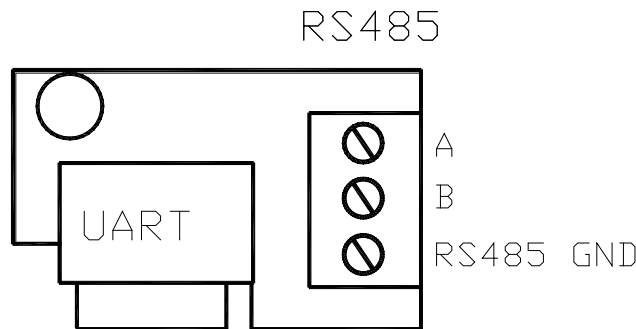

The adapter should be mounted perpendicular to the main PCB. **The adapter should be put on the UART connector with all five pins connected.** All five pins of the UART must be connected. For aSENSE the adapter should be mounted with the RS-485 terminal facing the other terminals and the LED facing the display.

Push Button Operation for aSENSE MIII

This sensor has two push buttons, MENU and ESC. The YELLOW LED will acknowledge a successful push by a short flash. The push button MENU is available for selection of display value or maintenance commands, whereas ESC is available to escape back from a selected level.

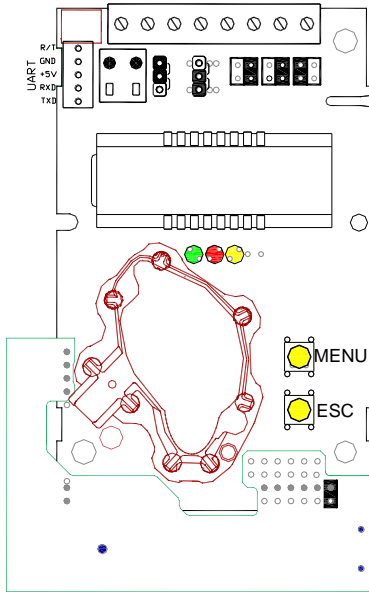

Figure 6 The sensor with push buttons

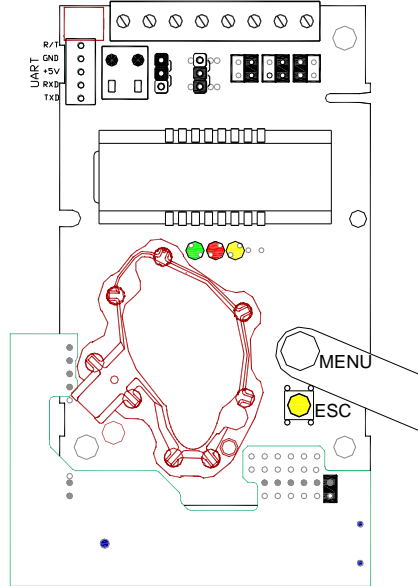

Figure 7 The push button MENU is pushed

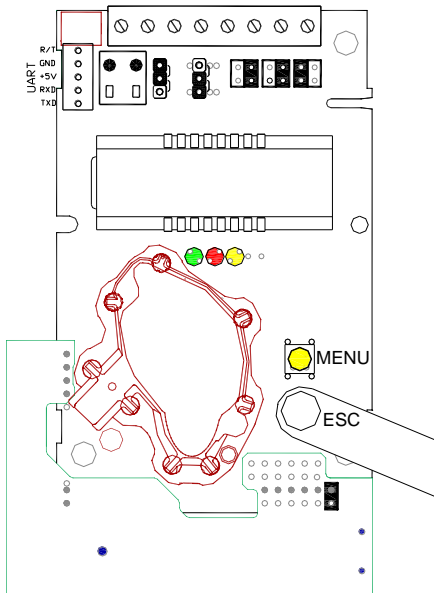

Figure 8 The push button ESC is pushed

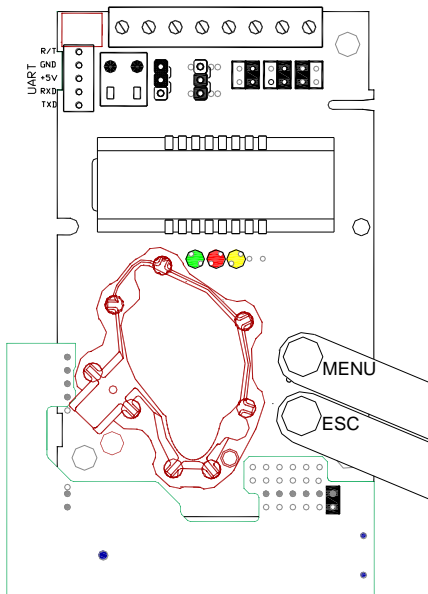

Figure 9 The ENTER command is done by pushing buttons MENU and ESC at the same time for about 14 seconds

Display modes

In DISPLAY MODE the DEFAULT operation is that the sensor alternates between carbon dioxide and carbon monoxide readings presentation. The push button MENU(+) is used to select the indicated value on the display to be the error code or the set points of temperature and CO₂. After power up the display will always return to the Default display mode. If a permanent change of default values is requested the PC software is to be used.

Function Line	Display	Time limit	Function description
0	CO / CO ₂	no	DEFAULT - Normal operation
1	Exxx	yes	Error code. If no error has been detected the code E0 is shown. The error code is reset with Entr(+/-).
2	Present CO and CO ₂ set points	no	Toggle between display of CO and CO ₂ set point with MENU(+).

Table III. On the display without entering the maintenance menu

Maintenance level

A number of execution options are available from the MAINTENANCE MENU (see Table IV). This level is accessed only from the display mode in the set points of CO and CO₂ selection. A two buttons push and an access code restrict access, intended for competent trained service personnel only. The Entr(+/-) command is done by PUSHING MENU AND ESC AT THE SAME TIME (hold down for about 14 seconds). The access code has eight binary digits; one press at MENU(+) equals 1 and one press at ESC(-) equals 0. The code value can be changed for your personal choice from the software UIP 4.3.

Always use the ESC button to return to the DEFAULT mode. Several pushes of the ESC button may be needed to return to the DEFAULT mode. The Entr(+/-) push (MENU & ESC) eventually leads to execution of functions, which causes temporary or permanently change of any parameter, that affects the system outputs!

Function Line	Display	Time limit	Function description
3	ECxx	yes	Access code to the service menu . The default value of the code is 255 (=11111111, that is eight presses on MENU(+)). Press down MENU(+) and let it scroll until it stops. The last two digits of the code are shown. Then ENTER to accept the selected code.
4a	SPCO	yes	For setting the set point of the CO concentration.
4b	The present CO set point	yes	For increase / decrease of the CO set point . The set point is increased by stepping with MENU(+) button. Decreasing is done by stepping with the ESC(-) button.
5a	SPc	yes	For setting the set point of the CO ₂ concentration
5b	The present CO ₂ set point	yes	For increase / decrease of the CO ₂ -concentration set point . The set point is increased by stepping with MENU(+) button. Decreasing is done by stepping with the ESC(-) button.
6a	AOUt	yes	First step of adjusting the analogue outputs MAX and MIN values
6b	An xx	no	Select analogue output by stepping with MENU(+) button
6c1	SetL	no	Leads to adjustment of the MIN value.

6d1	The present MIN value in % of FS	no	Increase the MIN value by stepping with the MENU(+) button. Decrease by stepping with the ESC(-) button. The output is set to the MIN value and can be checked with a multimeter.
6e1	Sure	no	The adjustment is saved by pressing Entr(+). Press ESC to return without saving.
6c2	SetH	no	Leads to adjustment of the MAX value
6d2	The present MAX value in % of FS	no	Increase MAX value by stepping with the MENU(+) button. Decrease by stepping with the ESC(-) button. The output is set to the MAX value and can be checked with a multimeter.
6e2	Sure	no	The adjustment is saved by pressing Entr(+). Press ESC to return without saving.
7	CALb	yes	Background calibration of the CO sensor and the CO₂-sensor with fresh air. An easy way to correct the zero point error. The sensor needs fresh air (380–420ppm CO ₂). The calibration must be confirmed by pressing Entr(+). The CO ₂ sensor is calibrated to 400ppm CO ₂ and the CO sensor to 0ppm CO.
7a	Sure	yes	Confirm that a background calibration shall be done.
8	CAL	yes	Zero point calibration of the CO sensor and the CO ₂ sensor. The sensor needs zero gas. See the zero point calibration instruction. The calibration must be confirmed by pressing Entr(+).
8a	Sure	yes	Confirm that a zero point calibration shall be done.

Table IV. Maintenance functions available on aSENSE MIII to set output limits. Time limit refers to an internal time-out that returns the LCD and maintenance function back to normal. ENTER is a simultaneous pressing on MENU and ESC.

PLEASE NOTE! If a power failure happens when the sensor has Out(1)...(4) locked to min/max limits, then the sensor will have this output locked when the power returns. It is necessary to enter this menu item and release the output manually!

EXAMPLE I:

Setting of the MAX value of the analogue outputs

The access code is time limited. If the time limit is exceeded the sensor returns to DEFAULT.

ENTR =MENU(+) and ESC(-) are pushed simultaneously.

1. At the start of the setting the sensor is in DEFAULT.
2. Push MENU(+) once to reach the error code. The display shows E + the error code number. No error is shown as E000.
3. Push MENU(+) once. The display shows the CO set point e.g. 35.
4. Push ENTR(+/-) once. The display shows EC and two digits. Enter the access code to the service menu. If the default code is used do like this: Push MENU(+) until the digits stop. The display shows EC55. If the correct code is not entered before the time limit exceeds the sensor returns to DEFAULT.
5. Push ENTR(+/-) once. The display shows SPCO to set the CO set point.
6. Push MENU(+) once to reach the carbon dioxide set point. The display shows SP C.

7. Push MENU(+) once to reach the setting of analogue outputs. The display shows AOuT.
8. Push ENTR(+/-) to reach the output to be set. The display shows An and two digits e.g. An 01. Step to the requested output by pushing MENU(+).
9. Push ENTR(+/-) to reach the setting of the MIN value. The display shows Set L.
10. Push MENU(+) to reach the setting of the MAX value. The display shows Set H.
11. Push ENTR(+/-) to set the MAX value of the output. The display shows the numerical value in % e.g. the standard setting 100.0 % or previously set value. Push MENU(+) to increase the MAX value. Push ESC(-) to decrease the MAX value. Push ENTR(+/-). The display shows Sure. Push ENTR(+/-) to save the setting and return to Set H. Push MENU(+) or ESC(-) to return to Set H without saving the new setting. Push ESC(-) to return to the output to be set, item 12. Push ESC(-) once again to return to the setting of analogue outputs item 11.

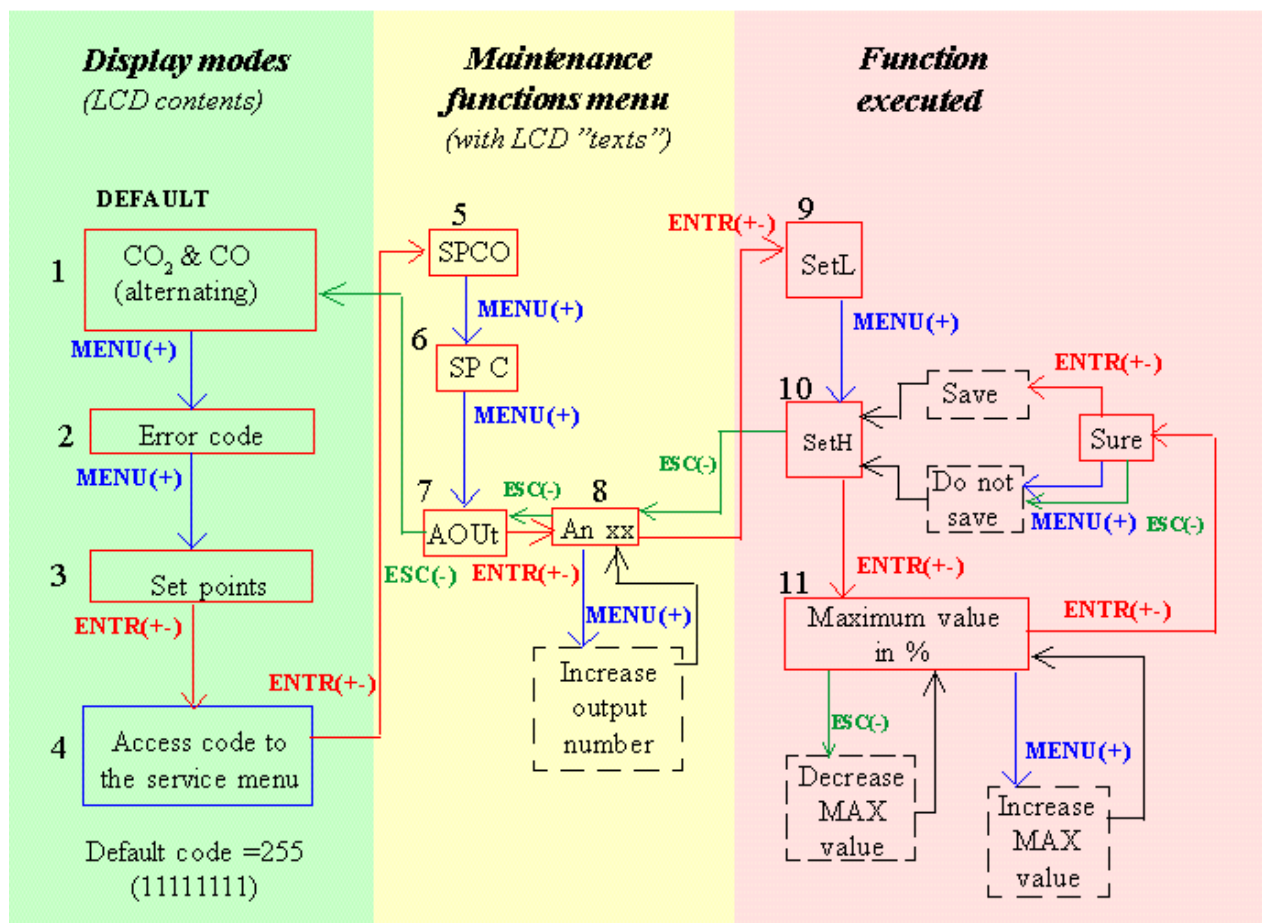

Figure 10 Maintenance functions available on aSENSE MIII to set output limits. Only flow chart for setting High limits is shown, but Low limits are set in the very same way. The numbers in the flow chart refers to the points in example 1. Function blocks that are time limited are indicated by blue borders. Time limit refers to an internal time-out that returns the LCD and maintenance function back to normal. ENTER is a simultaneous pressing on MENU and ESC.

EXAMPLE II:

Setting of set points for carbon monoxide concentration and carbon dioxide concentration, the MAX and MIN values of the analogue outputs and calibration of the sensor

The access code and the recalibration of the sensor are time limited. If the time limit is exceeded the sensor returns to DEFAULT.

ENTR =MENU(+) and ESC(-) are pushed simultaneously.

1. At the start of the setting the sensor is in DEFAULT.
2. Push MENU(+) once to reach the error code. The display shows E + the error code number. No error is shown as E000.
(Push ESC(-) to return to DEFAULT if requested)
3. Push MENU(+) once. The display shows the CO set point e.g. 35ppm and the carbon dioxide set point e.g. 750ppm.
(Push ESC(-) to return to DEFAULT if requested.)
4. Push ENTR(+/-) once. The display shows EC and two digits. Enter the access code to the service menu. If the default code is used do like this: Push MENU(+) until the digits stop. The display shows EC55. If the correct code is not entered before the time limit exceeds the sensor returns to DEFAULT.
5. Push ENTR(+/-) once. The display shows SPCO to set the carbon monoxide set point.
6. Push ENTR(+/-) once. The display shows the carbon monoxide set point e.g. ex 35ppm. Push MENU(+) to increase the set point value in steps of 1ppm.
Push ESC(-) to decrease the set point value in steps of 1ppm.
7. Push ENTR(+/-) once when the set point is set. The display shows SPCO.
Push ESC(-) to return to DEFAULT.
8. Push MENU(+) once to reach the carbon dioxide set point.
The display shows SP C.
9. Push ENTR(+/-) once. The display shows the carbon dioxide set point e.g. 750ppm. Push MENU(+) to increase the set point value in steps of 50ppm.
Push ESC(-) to decrease the set point value in steps of 50ppm.
10. Push ENTR(+/-) once when the set point is set. The display shows SP C.
Push ESC(-) to return to DEFAULT.
11. Push MENU(+) once to reach the setting of analogue outputs.
The display shows AOUt.
12. Push ENTR(+/-) to reach the output to be set. The display shows An and two digits e.g. An 01.
Step to the requested output by pushing MENU(+).
13. Push ENTR(+/-) to reach the setting of the MIN value. The display shows Set L.
14. Push ENTR(+/-) to set the MIN value of the output. The display shows the numerical value in % e.g. the standard setting 0.0 % or previously set value. Push MENU(+) to increase the MIN value. Push ESC(-) to decrease the MIN value. Push ENTR(+/-). The display shows Sure. Push ENTR(+/-) to save the setting and return to Set L. Push MENU(+) or ESC(-) to return to Set L without saving the new setting.
15. Push MENU(+) to reach the setting of the MAX value. The display shows Set H.

16. Push ENTR(+/-) to set the MAX value of the output. The display shows the numerical value in % e.g. the standard setting 100.0 % or previously set value. Push MENU(+) to increase the MAX value. Push ESC(-) to decrease the MAX value. Push ENTR(+/-). The display shows Sure. Push ENTR(+/-) to save the setting and return to Set H. Push MENU(+) or ESC(-) to return to Set H without saving the new setting. Push ESC(-) to return to the output to be set, item 12. Push ESC(-) once again to return to the setting of analogue outputs item 11.
17. Push MENU(+) to reach the calibration with fresh air. The sensor needs fresh air, air with 400ppm carbon dioxide. The display shows CALb. Push ENTR(+/-). The display shows Sure. Push ENTR(+/-) to confirm that a background calibration should be done. After completed background calibration the sensor returns to DEFAULT. If a background calibration should not be executed push MENU(+) or ESC(-). The background calibration has a time limit.
18. Push MENU(+) to reach the zero point calibration. The sensor needs carbon dioxide free air or gas. . The display shows CAL. Push ENTR(+/-). The display shows Sure. Push ENTR(+/-) to confirm that a zero point calibration should be done. After completed zero point calibration the sensor returns to DEFAULT. If a zero point calibration should not be executed push MENU(+) or ESC(-). The zero point calibration has a time limit.

FUNCTIONAL TEST of CO₂ / CO sensor aSENSE MIII

Functional test

The unit has three LED's – green, yellow and red. These LED's indicate the status of the controller. An internal delay function prevents the alarm functions of the relay and OUT4 output during two minutes after power up. The alarm outputs may be tested after the two minutes delay

Green LED: "No alarm situation" is lit, when the relay is contact closed.

Yellow LED: "Call for maintenance" is lit, if an error flag is set or the measurement is out of range. This information is also shown on the display by the wrench icon. Any push button press, or executed maintenance function, is acknowledged by emission from this LED. If an error has been detected both the yellow and red LEDs are lit.

Red LED: "Alarm high gas concentrations" is lit, when the open collector output is activated (contact closed). The CO concentration is 35ppm or more OR the CO₂ concentration is 1500ppm or more OR if the yellow LED is lit.

A simple and visual functional test can easily be performed. Take a breath and blow the air from a distance of a few centimetres on the sensor. The sensor will detect a rapid increase in the carbon dioxide concentration. The red LED is lit and the green LED is turned off when the CO or CO₂ concentration goes above the pre-set value. If the sensor is connected to a controller, the flow of the ventilation system will eventually increase by change of the fan speed or opening of a damper actuator (depending on the installation/application).

Test gas verification

If the measurement of a sensor is to be verified, a test gas with carefully determined concentration of CO and CO₂ must be used. For zero calibration pure nitrogen or air that has passed through a chemical absorber should be used. In fresh air the carbon monoxide concentration is nearly zero. The Zero calibration kit can be used to produce carbon dioxide free air. Check the CO and CO₂ values of the display or the voltage of the output 1 for CO and the voltage of the output 2 for CO₂ with a multimeter when the values have stabilised.

When a zero calibration shall be executed a plastic tube with 2.2 mm outer diameter and 0,8 mm inner diameter shall be inserted in marked holes of the sensor. Plastic tubing is connected to the tube. The gas flow should be between 0.3 and 1.0 l/min.

The yellow LED flashes when a calibration is executed. A calibration will only be executed if the gas concentration is stable. If the yellow LED does not flash after 8 seconds no calibration has been executed. Then try to do another calibration.

Marking	Function
CALb CO ₂	Background calibration = CO ₂ sensor calibration with fresh air. An easy way to correct the zero point error. The sensor needs fresh air (380–420ppm CO ₂). The CO ₂ sensor is calibrated to 400ppm CO ₂ .
CAL CO	Zero point calibration of the CO sensor with fresh air. The CO sensor is calibrated to 0ppm CO

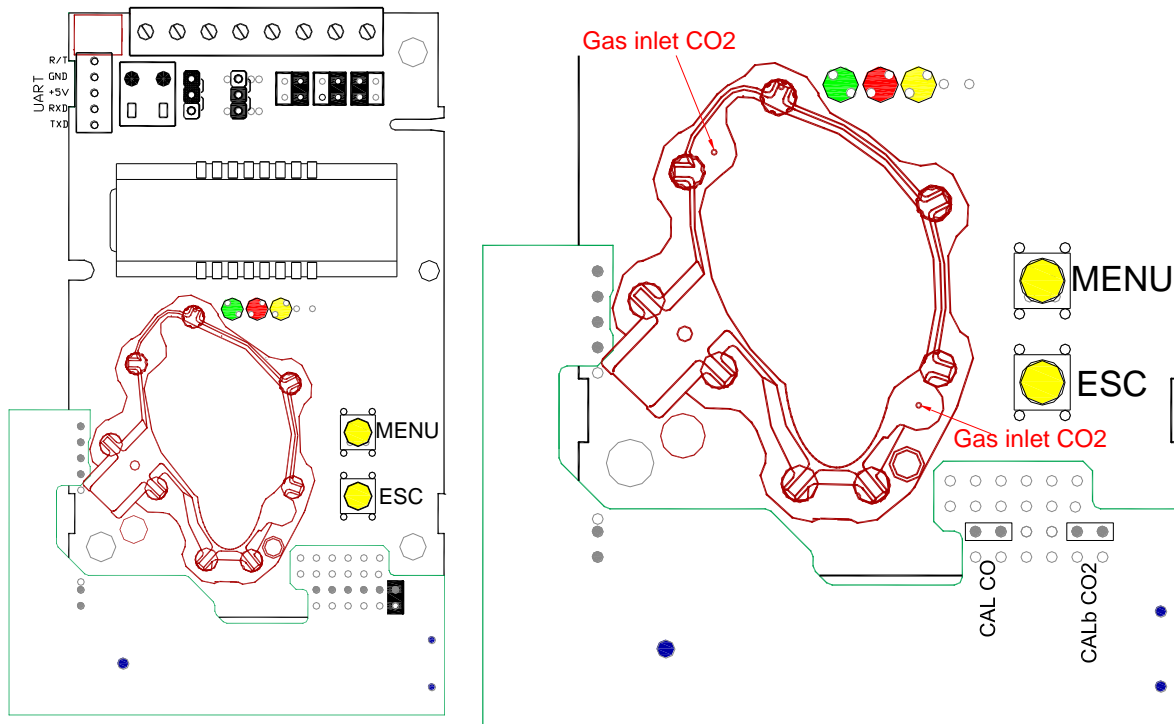

Figure 11 The PCB with the calibration jumper in default position. An enlarged part of the PCB with marked gas inlets and jumper positions for calibration is shown at right.

PLEASE NOTE!

The sensor accuracy is defined at continuous operation (at least 3 weeks after installation)

Self-diagnostics

The system contains complete self-diagnostic procedures. A full system test is executed automatically every time the power is turned on. For aSENSE MIII the internal voltage regulators and outputs are checked. In addition, constantly during operation, checking the valid dynamic measurement ranges checks the sensor probes against failure. These different system checks return error bytes to the system RAM. If any error is detected, the yellow LED will be lit until the error has vanished and the error flag is reset. “Warm up” and “Out of Range” are the only bits that are reset automatically after return to normal state. All other error bits have to be reset manually after return to normal state – either by pushing MENU & ESC buttons simultaneously for (=Entr(+)) or by power off and restart.

By pushing the push button “MENU” the error code number Exxx is shown on the LCD. Descriptions of the different codes are listed below.

Error code and action plan

Bit #	Error code	Error description	Suggested action
0	N/A	Fatal Error Yellow LED continuously flashes. Push buttons are not operating.	Try to restart sensor by power OFF/ON. Contact local distributor
1	2	Reserved	
2	4	Algorithm Error. Indicate wrong EEPROM configuration.	Try to restart sensor by power OFF/ON. Check detailed settings and configuration with UIP software version 4.3 and higher. Contact local distributor
3	8	Output Error Detected errors during output signals calculation and generation.	Check connections and loads of outputs. Check detailed status of outputs with UIP software version 4.3 and higher.
4	16	Self-Diagnostic Error. May indicate the need of zero calibration or sensor replacement.	Check detailed self-diagnostic status with UIP software version 4.3 and higher. Contact local distributor
5	32	Out of Range Error Accompanies most of other errors. Can also indicate overload or failures of sensors and inputs. Resets automatically after source of error disappearance.	Try sensor in fresh air. Check connections of temperature and relative humidity probe. Check detailed status of measurements with UIP software version 4.3 and higher. See Note 1!
6	64	Memory Error Non-fatal error during memory operations.	Check detailed settings and configuration with UIP software version 4.3 and higher.
7	128	Warm Up state Is always set after power up or power failure. Resets after restart sequence	If it doesn't disappear in half a minute, check power stability.

Table V. Error codes

Note 1. Any probe is out of range. Occurs, for instance, during over exposure of CO₂ sensor, in which case the error code will automatically reset when the measurement values return to normal. Could also indicate the need of zero point calibration. A background calibration using push button function “bCAL” will cure this error (a more exact zero calibration using “CAL” may be performed later, if required). If the CO₂ readings are normal, and still the error code remains, the temperature or relative humidity sensor can be defect or the connections to these are broken.

Please remark: If several errors are detected at the same time the different error code numbers will be added together into one single error code!

Maintenance

The aSENSE MIII is basically maintenance free. An internal self-adjusting calibration function takes care of normal long term drift associated to the CO and CO₂ sensor. To secure the highest accuracy, a time interval of five years is recommended between calibrations, unless some special situations have occurred. A zero calibration can be performed by use of the push button functions, or for a complete overview by use of a PC together with the UIP software version 4.3 (or higher). This software can be free downloaded from www.senseair.com. A RS232-cable is needed and can be ordered from Senseair. The cable is to be connected to the UART port slide connector (Fig 10). For change of control parameters and re-calibration (CO₂ and CO) this PC tool has to be used. The check can be done on site without interfering with the ventilation system.

Cleaning (exterior only):

Use mild detergent (no harsh chemicals) and wipe dry with a dry cloth.

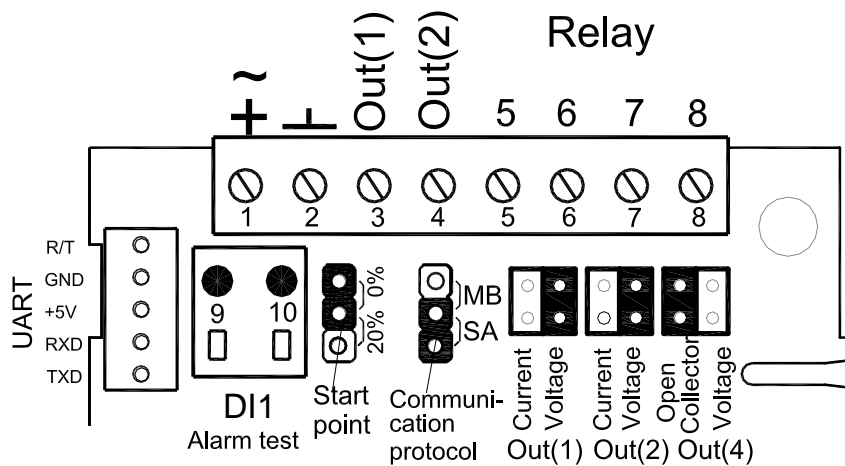

Figure 12. The aSENSE MIII printed circuit board with the connection terminal area is enlarged.

The terminal DI1 may be used for forced ventilation. If the sensor has a heater it is connected to + and -.



www.senseair.com