

Installation Manual

eSENSE Slim 0-5V

CO₂ transmitter

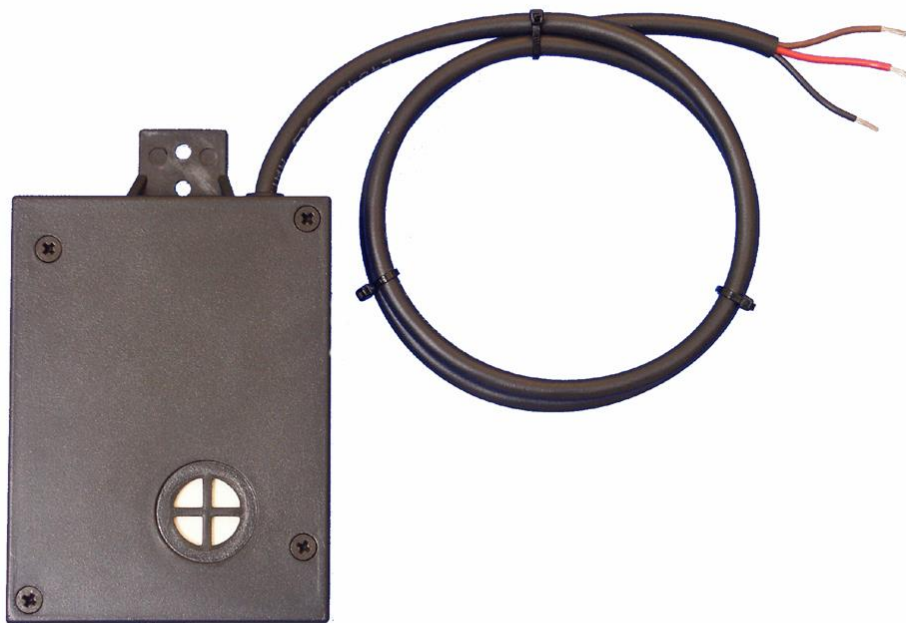

eSENSE™ Slim

General

The IAQ-sensor product *eSENSE Slim* (sensor in industrial housing) is used to measure indoor air carbon dioxide concentration. The 300 mm long cable connected to the PCB makes it possible to place the sensor where the mounting is difficult.

The unit is designed for connecting to Direct Digital Control (DDC) with 0-5V signal inputs.

The *eSENSE Slim* has a permanently connected cable to the PCB.

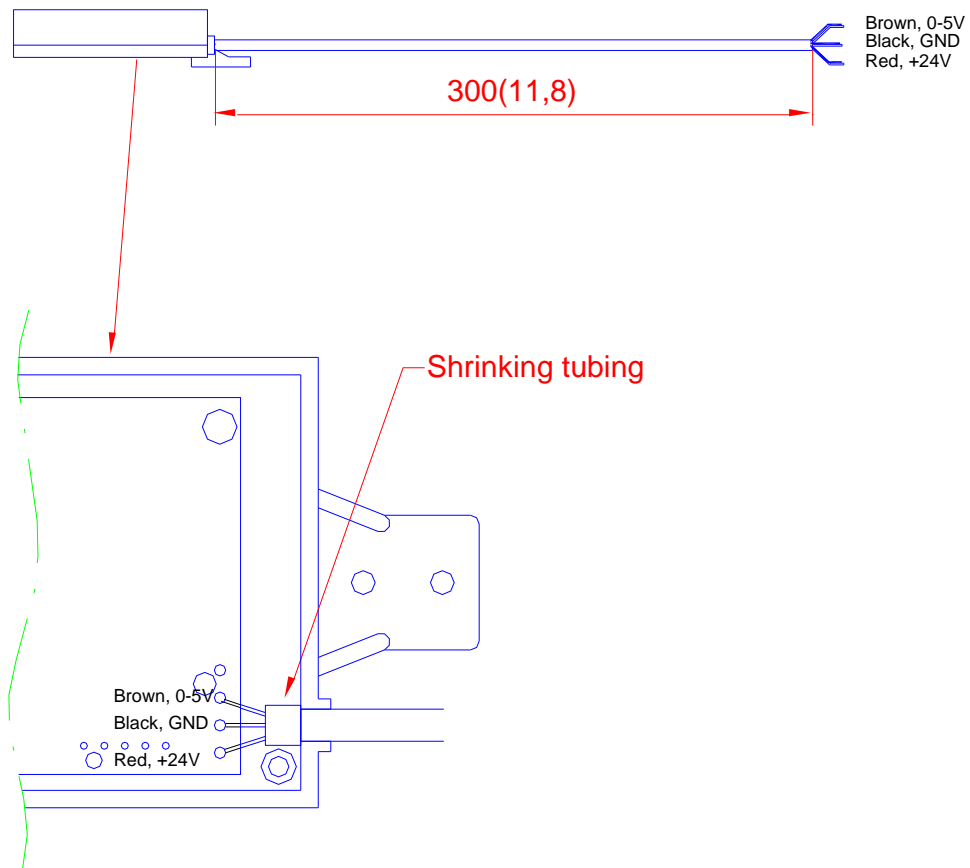

Figure 1. The *eSENSE-Slim* with the cable.

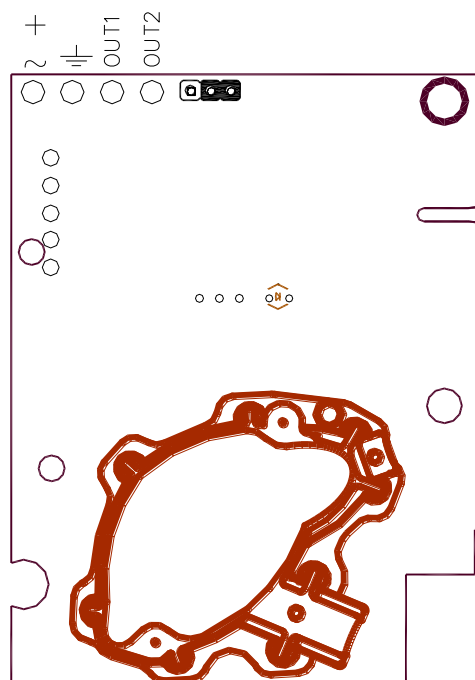



Figure 2. The *eSENSE* PCB. The brown cable is connected to OUT1 voltage output 0-5VDC

Electrical connections

The power supply has to be connected to +~ and .  is considered as system ground. The same ground reference has to be used for the eSENSE unit and for the DDC/signal receiver.



PLEASE NOTE!

The same ground reference has to be used for the eSENSE unit and for the control system!

Connection Terminal	Function	Electrical Data	Remarks
+~	Power (+)	24 VAC/DC+ (+-20%), 2W	Red
	Power ground (-)	24 VAC/DC-	Black
OUT 1	Analogue Output 1 (+)	0-5 VDC	Brown 0-2000 ppm CO ₂
OUT 2	Analogue Output 2 (+)	2-10 VDC	Not connected

Table I. Electrical terminal connections for eSENSE

Output Configurations

The sensors/controllers are supplied from the factory with a 0.-.5VDC linear output for OUT1 (see Table I).

Self diagnostics

The system contains complete self-diagnostic procedures. A full system test is executed automatically every time the power is turned on. In addition, constantly during operation, the sensor probe is checked against failure.

PLEASE NOTE!

The sensor accuracy is defined at continuous operation (at least 3 weeks after installation)

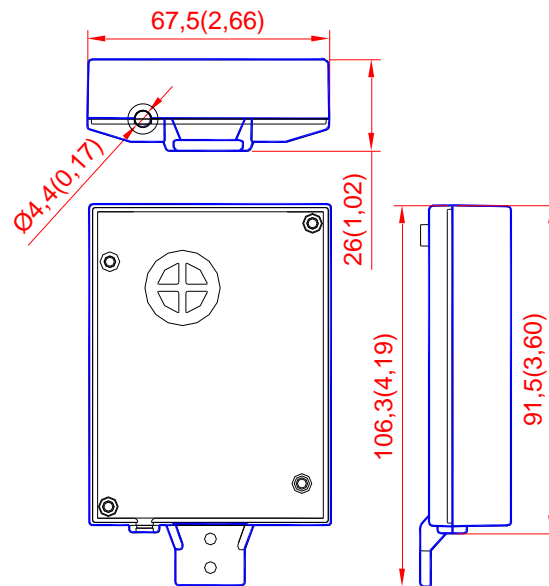

Figure 3. The dimensions of the sensor in mm and (inches)

This product is in accordance with the EMC 2004/108/EC, 92/31/EEG including amendments by the CE-marking Directive 93/68/EEC.
 The product fulfils the following demands: EN 61000-4-2 level 2, EN 61000-4-3 level 2, EN 61000-4-4 level 4, EN 61000-4-6, EN 61000-4-8 level 4, EN 55022 class B

SenseAir® AB (headquarter)
 Stationsgatan 12 Phone: +46-(0)653 - 71 77 70
 Box 96 E-mail: info@senseair.com
 820 60 Delsbo
 SWEDEN Web site: www.senseair.com