

# User Manual

## tSENSE (Disp)

CO<sub>2</sub>, temperature and  
relative humidity sensor



### General

tSENSE (Disp) for wall mounting measures indoor air carbon dioxide concentration, temperature and relative humidity in rooms. tSENSE (Disp) is available with or without colour touch display (LCD).

The unit connects to Direct Digital Control (DDC).

Linear outputs are pre-programmed as CO<sub>2</sub>, temperature and relative humidity transmitter. Measuring ranges can be modified from PC (Windows) software UIP (version 5 or higher) and USB communication cable, alternative via Modbus or BACnet.



## Table of contents

General.....	1
Table of contents.....	2
Opening of housing .....	3
Download of software UIP .....	3
Enter PIN code .....	4
Output Configurations .....	4
Outputs .....	5
Out1/Out2/Out3 .....	5
Voltage range.....	5
Select source .....	6
Types.....	7
Measure range settings .....	7
Relay.....	8
Communication settings .....	9
Protocol.....	9
Address/Baud rate .....	9
Connection configurations.....	10
Measured values .....	10
CO <sub>2</sub> /Temperature/Humidity .....	10
Display settings .....	11
Limits.....	11
Chart 24h/Week.....	11
Screen settings.....	12
Brightness .....	12
Background.....	12
Screensaver, Time setting .....	12
Toggle (Time and CO <sub>2</sub> and/or Temperature and/or Humidity).....	13
Meter settings .....	14
Meter information.....	14
Temperature unit (°C/°F).....	15
Calibration options CO <sub>2</sub> .....	15
Zero cal/Background/Target cal .....	16
ABC.....	17
Temperature/Humidity Offset.....	18
Automatic system test .....	19
Error codes and action plans.....	20
UIP Logger .....	21
Export Logger Data.....	21
Log to file .....	22
PIN codes .....	23
Change PIN code for access to display settings (PIN1).....	23
Toggle PIN1 On/Off .....	23
Change PIN code for access to meter settings (PIN2).....	23
Maintenance .....	24

# Opening of housing

See Installation Manual

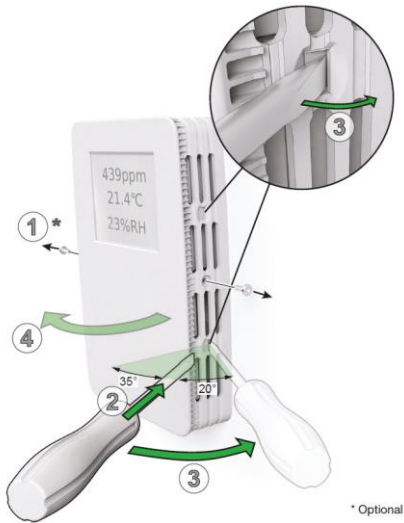

Figure 1

# Download of software UIP

senseair.com

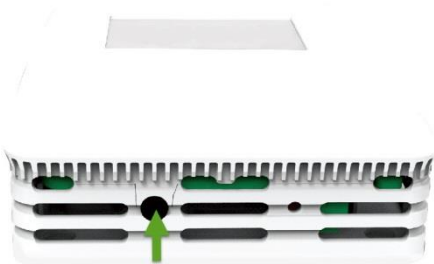













Figure 2: Connection to PC via phone jack  
Connect Interface cable USB – 3.5mm Art.No.:00-0-0070

# Check for updates

<p><b>1</b></p>	<p><b>2</b> New version available</p>	<p><b>2</b></p>
<p><b>3</b></p>	<p><b>4</b></p>	

Senseair

## Enter PIN code

<p><b>0</b> Power ON</p> 	<p><b>1</b></p> <table border="1"> <tr><td>CO<sub>2</sub></td><td>429ppm</td></tr> <tr><td>Temperature</td><td>23.1°C</td></tr> <tr><td>Humidity</td><td>21%RH</td></tr> <tr><td></td><td></td></tr> </table> 	CO <sub>2</sub>	429ppm	Temperature	23.1°C	Humidity	21%RH			<p><b>2</b> PIN1: 1111</p> <p>Enter PIN 1111</p> <table border="1"> <tr><td></td><td>2</td><td>3</td></tr> <tr><td></td><td>5</td><td>6</td></tr> <tr><td></td><td>8</td><td>9</td></tr> <tr><td>Del</td><td>0</td><td>«</td></tr> </table>		2	3		5	6		8	9	Del	0	«	<p><b>3</b></p> <table border="1"> <tr><td>CO<sub>2</sub></td><td>Screen</td></tr> <tr><td>Temperature</td><td>Settings</td></tr> <tr><td>Humidity</td><td></td></tr> <tr><td></td><td></td></tr> <tr><td></td><td>«</td></tr> </table>	CO <sub>2</sub>	Screen	Temperature	Settings	Humidity					«
CO <sub>2</sub>	429ppm																																
Temperature	23.1°C																																
Humidity	21%RH																																
	2	3																															
	5	6																															
	8	9																															
Del	0	«																															
CO <sub>2</sub>	Screen																																
Temperature	Settings																																
Humidity																																	
																																	
	«																																
<p><b>4</b> PIN2: 2001</p> <p>Enter PIN 2001</p> <table border="1"> <tr><td></td><td>2</td><td>3</td></tr> <tr><td></td><td>5</td><td>6</td></tr> <tr><td></td><td>8</td><td>9</td></tr> <tr><td>Del</td><td>0</td><td>«</td></tr> </table>		2	3		5	6		8	9	Del	0	«	<p><b>5</b></p> <table border="1"> <tr><td>Meter</td></tr> <tr><td>Measurements</td></tr> <tr><td>Outputs</td></tr> <tr><td>Misc</td><td>«</td></tr> </table>	Meter	Measurements	Outputs	Misc	«															
	2	3																															
	5	6																															
	8	9																															
Del	0	«																															
Meter																																	
Measurements																																	
Outputs																																	
Misc	«																																

## Output Configurations

Terminal	Default Output	Default Output Range	Outputs of this sensor	Output Ranges of this sensor
OUT(1)	0 – 10VDC	0 – 2000ppm CO <sub>2</sub>	See label	See label
OUT(2)	0 – 10VDC	0 – 50°C	See label	See label
OUT(3)	0 – 10VDC	0 – 100%RH	See label	See label

Table 1. Default output configurations of tSENSE (Disp)

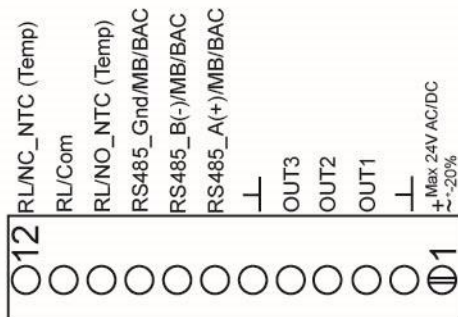







Figure3: Screw Terminal

Connect the sensor to PC with the connect interface cable USB – 3.5mm Art.No.: 00-0-0070

The sensor is supplied with 0 - 10VDC linear outputs for Out(1), Out(2) and Out(3) (see Table 1). Alternative output ranges can be configured with PC software UIP (version 5 or higher). See information at [senseair.com](http://senseair.com).









# Outputs

## Out1/Out2/Out3

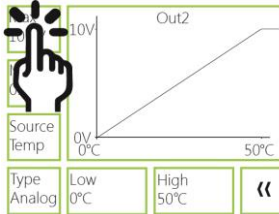
<b>1</b>	<b>2</b>	<b>3</b>	<b>4</b> Outputs																																		
<table border="1"> <tr><td>CO<sub>2</sub></td><td>429ppm</td></tr> <tr><td>Temperature</td><td>23.1°C</td></tr> <tr><td>Humidity</td><td>21%RH</td></tr> <tr><td></td><td></td></tr> </table> 	CO <sub>2</sub>	429ppm	Temperature	23.1°C	Humidity	21%RH			<table border="1"> <tr><td>CO<sub>2</sub></td><td>Screen</td></tr> <tr><td>Temperature</td><td>Set</td></tr> <tr><td>Humidity</td><td></td></tr> <tr><td></td><td>«</td></tr> </table> 	CO <sub>2</sub>	Screen	Temperature	Set	Humidity			«	<table border="1"> <tr><td>Enter PIN</td><td>2001</td></tr> <tr><td></td><td>2</td><td>3</td></tr> <tr><td></td><td>5</td><td>6</td></tr> <tr><td></td><td>8</td><td>9</td></tr> <tr><td>Del</td><td>0</td><td>«</td></tr> </table> 	Enter PIN	2001		2	3		5	6		8	9	Del	0	«	<table border="1"> <tr><td>Meter</td></tr> <tr><td>Measurements</td></tr> <tr><td>Outputs </td></tr> <tr><td>Misc «</td></tr> </table>	Meter	Measurements	Outputs 	Misc «
CO <sub>2</sub>	429ppm																																				
Temperature	23.1°C																																				
Humidity	21%RH																																				
CO <sub>2</sub>	Screen																																				
Temperature	Set																																				
Humidity																																					
	«																																				
Enter PIN	2001																																				
	2	3																																			
	5	6																																			
	8	9																																			
Del	0	«																																			
Meter																																					
Measurements																																					
Outputs 																																					
Misc «																																					

## Voltage range

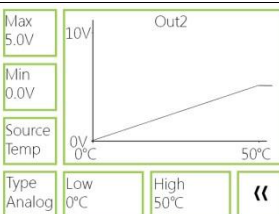
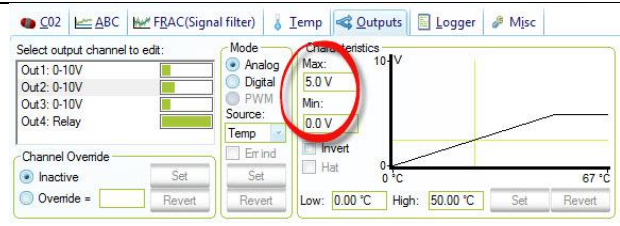
Max (the same approach with "Min")

<b>5</b> Out2	<b>6</b>	<b>7</b> Max	<b>8</b> 10.0V, 9.9V..5.0V..																											
<table border="1"> <tr><td>Out1</td><td>10.0V</td></tr> <tr><td>Out2 </td><td>4.8V</td></tr> <tr><td>Out3</td><td>4.8V</td></tr> <tr><td>Relay</td><td>1(active)</td></tr> <tr><td></td><td>«</td></tr> </table>	Out1	10.0V	Out2 	4.8V	Out3	4.8V	Relay	1(active)		«	<table border="1"> <tr><td>Out2</td><td>Temp</td></tr> <tr><td></td><td>«</td></tr> </table> 	Out2	Temp		«	<table border="1"> <tr><td>Source</td><td>Temp</td></tr> <tr><td>Type</td><td>Low 0°C</td><td>High 50°C</td></tr> <tr><td></td><td>«</td></tr> </table> 	Source	Temp	Type	Low 0°C	High 50°C		«	<table border="1"> <tr><td>Max limit</td><td>5.0V</td></tr> <tr><td></td><td>+</td></tr> <tr><td></td><td>«</td></tr> </table> 	Max limit	5.0V		+		«
Out1	10.0V																													
Out2 	4.8V																													
Out3	4.8V																													
Relay	1(active)																													
	«																													
Out2	Temp																													
	«																													
Source	Temp																													
Type	Low 0°C	High 50°C																												
	«																													
Max limit	5.0V																													
	+																													
	«																													
<b>9</b>	<b>10</b>	<b>UIP</b>																												
<table border="1"> <tr><td>Max limit</td><td>5.0V</td></tr> <tr><td>-</td><td>+</td></tr> <tr><td></td><td></td></tr> </table>	Max limit	5.0V	-	+			<table border="1"> <tr><td>Max</td><td>5.0V</td></tr> <tr><td>Min</td><td>0.0V</td></tr> <tr><td>Source</td><td>Temp</td></tr> <tr><td>Type</td><td>Low 0°C</td><td>High 50°C</td></tr> <tr><td></td><td>«</td></tr> </table> 	Max	5.0V	Min	0.0V	Source	Temp	Type	Low 0°C	High 50°C		«												
Max limit	5.0V																													
-	+																													
																														
Max	5.0V																													
Min	0.0V																													
Source	Temp																													
Type	Low 0°C	High 50°C																												
	«																													

# Select source

<p><b>7</b> Source</p>	<p><b>8</b></p> <p>Source CO2</p> <p>CO2 Temp RH</p> <p>Ch3 Ch4 Ch5</p> <p>Ch6 Ch7 Disable</p> <p>«</p>	<p><b>9</b></p> <p>Source CO2</p> <p>CO2 Temp RH</p> <p>Ch3 Ch4 Ch5</p> <p>Ch6 Ch7 Disable</p> <p>«</p>	<p><b>10</b></p>
<p>UIP <b>1</b> Source CO<sub>2</sub> selected</p>		<p><b>2</b> Set (Save)</p>	

# Types

## Analogue/Analogue Invert

<p><b>7</b> Analogue</p>	<p><b>8</b></p> <p>Type An,Inv</p> <p>Analog Analog Invert</p> <p>Digital Digital Invert</p>	<p><b>9</b></p> <p>Type An,Inv</p> <p>Analog Analog invert</p> <p>Digital Digital invert</p>	<p><b>10</b> Analogue invert</p>
--------------------------	--	--	----------------------------------

## UIP5 **1** Invert **2** Save (Set)

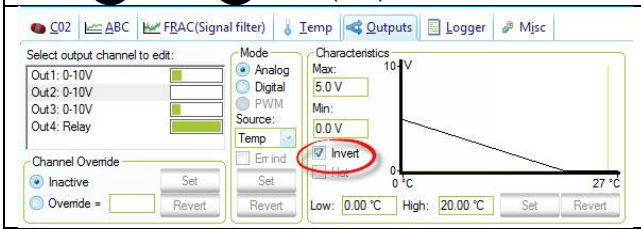

## Digital/Digital Invert

<p><b>10</b> Digital</p>	<p><b>10</b> Digital Invert</p>
--------------------------	---------------------------------

## Measure range settings

Low (the same approach with "High")

<p><b>7</b> Low 600ppm</p>	<p><b>8</b> 600, 550...400ppm</p> <p>Low 400ppm</p>	<p><b>9</b> Low 400ppm</p> <p>- +</p>	<p><b>10</b></p>
----------------------------	---	---------------------------------------	------------------



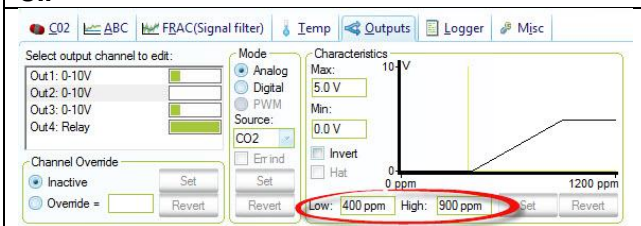







## UIP



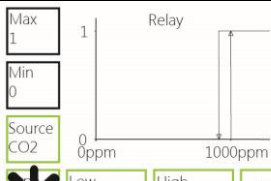

# Outputs

## Relay

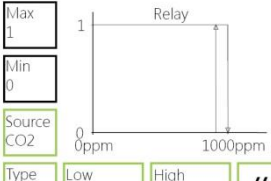
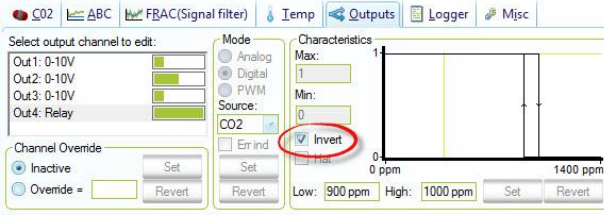
<p><b>1</b></p> <p>CO<sub>2</sub> 429ppm</p> <p>Temperature 23.1°C</p> <p>Humidity 21%RH</p> 	<p><b>2</b></p> <p>CO<sub>2</sub> Screen</p> <p>Temperature Settings</p> <p>Humidity</p>  <p>«</p>	<p><b>3</b></p> <p>Enter PIN 2001</p> <table border="1"> <tr><td>2</td><td>3</td></tr> <tr><td>5</td><td>6</td></tr> <tr><td>8</td><td>9</td></tr> <tr><td>0</td><td>«</td></tr> </table> 	2	3	5	6	8	9	0	«	<p><b>4</b> Outputs</p> <p>Meter</p> <p>Measurements</p> <p>Outputs</p> <p>Misc</p>  <p>«</p>
2	3										
5	6										
8	9										
0	«										
<p><b>5</b> Relay</p> <p>Out1 10.0V</p> <p>Out2 4.8V</p> <p>Out3 4.8V</p> <p>Relay 1(active)</p>  <p>«</p>	<p><b>6</b></p> <p>Relay CO2</p>  <p>«</p>	<p><b>7</b> Type Digital</p> <p>Max 1</p> <p>Min 0</p> <p>Source CO2</p> <p>Relay</p>  <p>Low 900ppm High 1000ppm</p>  <p>«</p>	<p><b>8</b></p> <p>Type Dig,Inv</p> <p>Digital Digital invert</p>  <p>«</p>								
<p><b>9</b></p> <p>Type Dig,Inv</p> <p>Digital Digital invert</p> 	<p><b>10</b></p> <p>Max 1</p> <p>Min 0</p> <p>Source CO2</p> <p>Relay</p>  <p>Type Low 900ppm High 1000ppm</p> <p>Dig,Inv</p> <p>«</p>	<p><b>UIP</b></p> <p>CO2 ABC FBAC(Signal filter) Temp Outputs Logger Misc</p> <p>Select output channel to edit:</p> <p>Out1: 0-10V</p> <p>Out2: 0-10V</p> <p>Out3: 0-10V</p> <p>Out4: Relay</p> <p>Mode: Digital</p> <p>Source: CO2</p> <p>Channel Override: Inactive</p> <p>Characteristics: Max: 1, Min: 0, Low: 900 ppm, High: 1000 ppm</p> <p><input checked="" type="checkbox"/> Invert</p> 									



# Communication settings

## Protocol



<p><b>5</b> RS-485</p> <p>Meter info RS-485</p> <p>PIN1 PIN1</p> <p>Reset</p> <p>«</p>	<p><b>6</b></p> <p>Protocol Auto</p> <p>Address 10</p> <p>Baudrate 9600</p> <p>Parity, Stop bits None, 1</p> <p>Reset needed to activate new communication settings</p> <p>«</p>	<p><b>7 NOTE!</b></p> <p>Protocol Auto</p> <p>Modbus BACnet</p> <p>«</p>	<p><b>8</b></p> <p>Protocol Auto</p> <p>Auto Modbus BACnet</p> <p>«</p>
<p><b>9 NOTE!</b></p> <p>Meter info RS-485</p> <p>PIN1 PIN2</p> <p>Reset</p> <p>«</p>	<p><b>UIP 1</b></p> <p>Temperature Unit (C/F) Auto</p> <p>Altitude(m) Modbus</p> <p>RS-485 Protocol (reset to activate new) BACnet</p> <p>RS-485 Baudrate (reset to activate new)</p> <p>RS-485 Parity (reset to activate new)</p> <p>RS-485 Stop bits (reset to activate new)</p> <p>Set Revert</p>		<p><b>2</b></p> <p>Property value</p> <p>Auto</p> <p>Modbus</p> <p>BACnet</p> <p>Set Revert</p>

## Address/Baud rate

<p><b>6</b></p> <p>Protocol Auto</p> <p>Address 10</p> <p>Baudrate 9600</p> <p>Parity, Stop bits None, 1</p> <p>Reset needed to activate new communication settings</p> <p>«</p>	<p><b>7</b></p> <p>Address 12</p> <p>-</p> <p>«</p>	<p><b>8</b></p> <p>Address 12</p> <p>- +</p> <p>«</p>	<p><b>9 NOTE!</b></p> <p>Meter info RS-485</p> <p>PIN1 PIN2</p> <p>Reset</p> <p>«</p>
<p><b>UIP Address 1</b></p> <p>Meter information</p> <p>Vendor Name SenseAir AB</p> <p>Product Code tSENSE</p> <p>Serial Number 0x030DA676</p> <p>Firmware 0x66010C</p> <p>Type ID 404</p> <p>Map Version 72</p> <p>Network Address 10</p> <p>Error Flags</p>	<p><b>2</b></p> <p>Meter information</p> <p>Vendor Name SenseAir AB</p> <p>Product Code tSENSE</p> <p>Serial Number 0x030DA676</p> <p>Firmware 0x66010C</p> <p>Type ID 404</p> <p>Map Version 72</p> <p>Network Address 12</p> <p>Error Flags</p>		<p><b>3</b></p> <p>Change Network Address?</p> <p>Are you sure you want to change meter network id from 10 to 12?</p> <p>Yes No</p>
<p><b>UIP Baud rate 1 Misc</b></p> <p>Temperature Unit (C/F)</p> <p>Altitude(m)</p> <p>RS-485 Protocol (reset to activate new)</p> <p>RS-485 Baudrate (reset to activate new)</p> <p>RS-485 Parity (reset to activate new)</p> <p>RS-485 Stop bits (reset to activate new)</p> <p>Select: 19200</p> <p>Set Revert</p>	<p><b>2</b></p> <p>Property value</p> <p>Select: 19200</p> <p>9600</p> <p>19200</p> <p>38400</p> <p>57600</p> <p>Set Revert</p>	<p><b>3</b></p> <p>Property value</p> <p>Select: 9600</p> <p>Set Revert</p>	

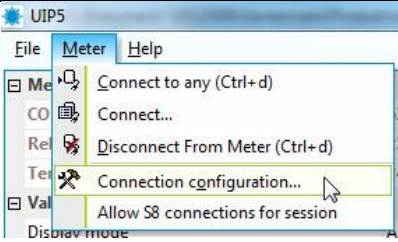
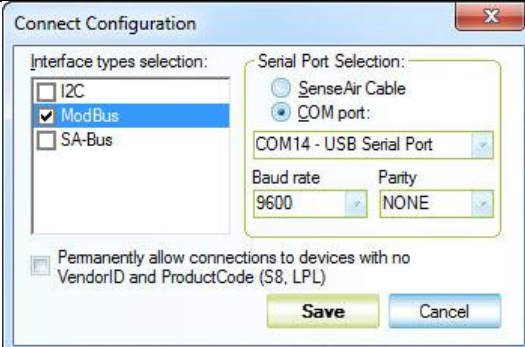
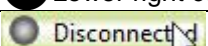

## Connection configurations

<p><b>1</b></p>	<p><b>2</b> ModBus <b>3</b> Choose SenseAir Cable if bought from SenseAir, otherwise choose COM Port <b>4</b> Save</p>	
		
<p><b>5</b> Lower right corner of screen</p> 	<p><b>6</b></p> 	

### NOTE!





UIP baud rate  $\neq$  RS-485 baud rate if tSENSE (Disp) is connected *via phone jack* (see fig. 2).

UIP baud rate = RS-485 baud rate if tSENSE (Disp) is connected *via screw terminal* (see fig. 3).

RS-485 Protocol parameter set to “Auto”: the sensor selects protocol depending on the protocol used on the network it is connected to. After power on the sensor then listens to the traffic on the RS-485 network. If the sensor detects valid BACnet or Modbus messages the sensor will start to use the detected protocol. Change communication settings via UIP requires Reset (Power OFF – Power ON) to be executed.

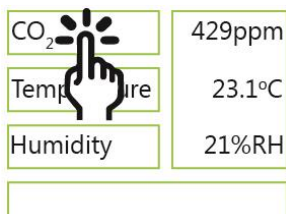
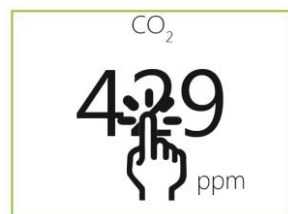
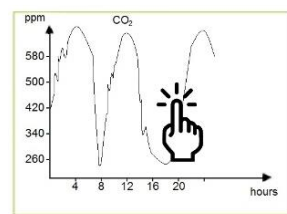
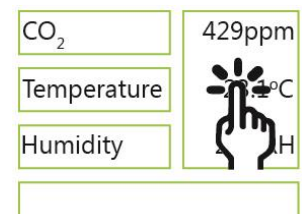
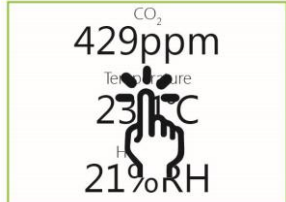
## Measured values

### CO<sub>2</sub>/Temperature/Humidity

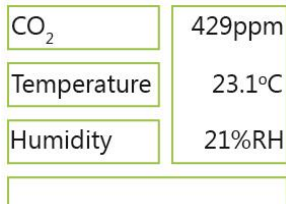
<p><b>1</b></p> 	<p><b>2</b></p> 	<p><b>3</b></p> 	<p><b>4</b></p> 
<p><b>5</b></p> 	<p><b>6</b></p> 	<p><b>7</b></p> 	<p><b>8</b></p> 
<p><b>9</b></p> 			





Senseair

# Display settings





## Limits

CO<sub>2</sub>/(Temperature)/(Humidity)



CO<sub>2</sub> Yellow/Red limit (Temp./Humidity, the same approach as for CO<sub>2</sub> limit settings)

<p><b>1</b></p> <p>CO<sub>2</sub> 429ppm</p> <p>Temperature 23.1°C</p> <p>Humidity 21%RH</p> 	<p><b>2</b></p> <p>CO<sub>2</sub> Screen</p> <p>Temp Settings</p> <p>Humidity</p> 	<p><b>3</b></p> <p>Yellow limit 600ppm</p> <p>Red limit 1000ppm</p> <p>Chart 24h</p> 	<p><b>4</b> 100,200...700ppm</p> <p>Yellow limit -700ppm-</p> 
<p>CO<sub>2</sub> red limit 1000ppm</p> <p>RH yellow limit 70%RH</p>	<p>CO<sub>2</sub> red limit 1000ppm</p>	<p>RH yellow limit 70%RH</p>	
<p>CO<sub>2</sub> 1205ppm</p> <p>Temperature 73.6°F</p> <p>Humidity 72%RH</p> 	<p>CO<sub>2</sub></p> <p>1205</p> <p>ppm</p>	<p>Humidity</p> <p>72.0</p> <p>%RH</p>	



## Chart 24h/Week

<p><b>1</b></p> <p>CO<sub>2</sub> 429ppm</p> <p>Temperature 23.1°C</p> <p>Humidity 21%RH</p> 	<p><b>2</b></p> <p>CO<sub>2</sub> Screen</p> <p>Temp Settings</p> <p>Humidity</p> 	<p><b>3</b></p> <p>Yellow limit 600ppm</p> <p>Red limit 1000ppm</p> <p>Chart 24h</p> 	<p><b>4</b></p> <p>CO<sub>2</sub>Chart Week</p> <p>24h</p> 
--	---	--	--





## Screen settings

<b>1</b>	<b>2</b>
<div style="display: flex; flex-direction: column;"> <div style="display: flex; justify-content: space-between; width: 100%;"> <span>CO<sub>2</sub></span> <span>429ppm</span> </div> <div style="display: flex; justify-content: space-between; width: 100%;"> <span>Temperature</span> <span>23.1°C</span> </div> <div style="display: flex; justify-content: space-between; width: 100%;"> <span>Humidity</span> <span>21%RH</span> </div> <div style="border: 1px solid black; height: 20px; width: 100%; margin-top: 5px;"></div> </div> 	<div style="display: flex; flex-direction: column;"> <div style="display: flex; justify-content: space-between; width: 100%;"> <span>CO<sub>2</sub></span> <span>Screen</span> </div> <div style="display: flex; justify-content: space-between; width: 100%;"> <span>Temperature</span> <span>Sett</span> </div> <div style="display: flex; justify-content: space-between; width: 100%;"> <span>Humidity</span> <span></span> </div> <div style="border: 1px solid black; height: 20px; width: 100%; margin-top: 5px; text-align: right;">«</div> </div> 

## Brightness



<b>3</b>	<b>4</b> 10, 20,...50%
<div style="display: flex; flex-direction: column;"> <div style="display: flex; justify-content: space-between; width: 100%;"> <span>Brightness</span> <span>10%</span> </div> <div style="display: flex; justify-content: space-between; width: 100%;"> <span>Background</span> <span>Normal</span> </div> <div style="display: flex; justify-content: space-between; width: 100%;"> <span>Display Scheme</span> <span>Active</span> </div> <div style="display: flex; justify-content: space-between; width: 100%;"> <span>Toggle</span> <span>Ind area</span> <span>«</span> </div> </div> 	<div style="display: flex; flex-direction: column;"> <div style="display: flex; justify-content: space-between; width: 100%;"> <span>Brightness</span> <span>50%</span> </div> <div style="display: flex; justify-content: space-between; width: 100%;"> <span>-</span> <span></span> </div> <div style="display: flex; justify-content: space-between; width: 100%;"> <span>Energy save brightness</span> <span></span> </div> <div style="display: flex; justify-content: space-between; width: 100%;"> <span>-</span> <span></span> </div> <div style="border: 1px solid black; height: 20px; width: 100%; margin-top: 5px; text-align: right;">«</div> </div> 

## Background

<b>3</b>	<b>4</b>	<b>5</b>	<b>6</b>
<div style="display: flex; flex-direction: column;"> <div style="display: flex; justify-content: space-between; width: 100%;"> <span>Brightness</span> <span>50%</span> </div> <div style="display: flex; justify-content: space-between; width: 100%;"> <span>Background</span> <span>Normal</span> </div> <div style="display: flex; justify-content: space-between; width: 100%;"> <span>Display Scheme</span> <span>Active</span> </div> <div style="display: flex; justify-content: space-between; width: 100%;"> <span>Toggle</span> <span>Ind area</span> <span>«</span> </div> </div> 	<div style="display: flex; flex-direction: column;"> <div style="display: flex; justify-content: space-between; width: 100%;"> <span>Background color</span> <span>Invert</span> </div> <div style="display: flex; justify-content: space-around; width: 100%; margin-top: 10px;"> <div style="border: 1px solid black; padding: 2px;">Normal</div> <div style="border: 1px solid black; padding: 2px;">Invert</div> </div> <div style="border: 1px solid black; height: 20px; width: 100%; margin-top: 5px; text-align: right;">«</div> </div> 	<div style="display: flex; flex-direction: column;"> <div style="display: flex; justify-content: space-between; width: 100%;"> <span>Background color</span> <span>Invert</span> </div> <div style="display: flex; justify-content: space-around; width: 100%; margin-top: 10px;"> <div style="border: 1px solid black; padding: 2px;">Normal</div> <div style="border: 1px solid black; padding: 2px;">Invert</div> </div> <div style="border: 1px solid black; height: 20px; width: 100%; margin-top: 5px; text-align: right;">«</div> </div> 	<div style="display: flex; flex-direction: column; background-color: black; color: white; padding: 5px;"> <div style="display: flex; justify-content: space-between; width: 100%;"> <span>Brightness</span> <span>50%</span> </div> <div style="display: flex; justify-content: space-between; width: 100%;"> <span>Background</span> <span>Invert</span> </div> <div style="display: flex; justify-content: space-between; width: 100%;"> <span>Sleep Scheme</span> <span>Active</span> </div> <div style="display: flex; justify-content: space-between; width: 100%;"> <span>Toggle</span> <span>Ind area</span> <span>«</span> </div> </div> 











## Screensaver, Time setting

Interval







<b>3</b>	<b>4</b>	<b>5</b> 3,4,5...10 s	<b>6</b> 50 s
<div style="display: flex; flex-direction: column;"> <div style="display: flex; justify-content: space-between; width: 100%;"> <span>Brightness</span> <span>50%</span> </div> <div style="display: flex; justify-content: space-between; width: 100%;"> <span>Background</span> <span>Normal</span> </div> <div style="display: flex; justify-content: space-between; width: 100%;"> <span>Display Scheme</span> <span>Active</span> </div> <div style="display: flex; justify-content: space-between; width: 100%;"> <span>Toggle</span> <span>rea</span> <span>«</span> </div> </div> 	<div style="display: flex; flex-direction: column;"> <div style="display: flex; justify-content: space-between; width: 100%;"> <span>Display Scheme</span> <span>Interval</span> </div> <div style="display: flex; justify-content: space-between; width: 100%;"> <span>Active</span> <span></span> </div> <div style="display: flex; justify-content: space-between; width: 100%;"> <span>Energy save</span> <span></span> </div> <div style="display: flex; justify-content: space-between; width: 100%;"> <span>Inte</span> <span>«</span> </div> </div> 	<div style="display: flex; flex-direction: column;"> <div style="display: flex; justify-content: space-between; width: 100%;"> <span>Sleep Interval</span> <span>10s</span> </div> <div style="display: flex; justify-content: space-between; width: 100%;"> <span>-</span> <span></span> </div> <div style="border: 1px solid black; height: 20px; width: 100%; margin-top: 5px; text-align: right;">«</div> </div> 	

### Toggle (Time and CO<sub>2</sub> and/or Temperature and/or Humidity)

Toggle time





<p><b>3</b></p> <p>Brightness 50%</p> <p>Background Normal</p> <p>Display Scheme Interval</p> <p>Toggle Ind area</p> 	<p><b>4</b></p> <p>Toggle Time 3s - +</p> <p>CO<sub>2</sub> X</p> <p>Temperature X</p> <p>Humidity X «</p> 	<p><b>5</b></p> <p>Toggle Time 3s - +</p> <p>CO<sub>2</sub> X</p> <p>Temperature X</p> <p>Humidity X</p> 	<p><b>6</b></p> <p>Brightness 50%</p> <p>Background Normal</p> <p>Display Scheme Interval</p> <p>Toggle Ind area</p> 
<p><b>7</b></p> <p>CO<sub>2</sub> Screen</p> <p>Temperature Settings</p> <p>Humidity</p> 	<p><b>8</b> Check</p> <p>CO<sub>2</sub> 429ppm</p> <p>Temperature 23.1°C</p> <p>Humidity 21.0%RH</p> 	<p><b>9</b></p> <p>CO<sub>2</sub> 429ppm</p> <p>Temperature 23.1°C</p> <p>Humidity 21.0%RH</p> 	<p><b>10</b> 3 s</p> <p>CO<sub>2</sub> 429 ppm</p> 
<p><b>11</b> 3 s</p> <p>Temperature 23.1 °C</p> 	<p><b>12</b> 3 s</p> <p>Humidity 21.0 %RH</p> 	<p><b>13</b></p>	

### Toggle CO<sub>2</sub> and/or Temperature and/or Humidity

<p><b>3</b></p> <p>Brightness 50%</p> <p>Background Normal</p> <p>Display Scheme Interval</p> <p>Toggle Ind area</p> 	<p><b>4</b></p> <p>Toggle Time 3s - +</p> <p>CO<sub>2</sub></p> <p>Temperature</p> <p>Humidity X «</p> 	<p><b>5</b></p> <p>Toggle Time 3s - +</p> <p>CO<sub>2</sub></p> <p>Temperature X</p> <p>Humidity X</p> 	<p><b>6</b></p> <p>CO<sub>2</sub> 429ppm</p> <p>Temperature 23.1°C</p> <p>Humidity 21.0%RH</p> 
<p><b>7</b> Will NOT show up</p> <p><del>CO<sub>2</sub> 429 ppm</del></p>	<p><b>8</b> 3 s</p> <p>Temperature 23.1 °C</p> 	<p><b>9</b> 3 s</p> <p>Humidity 21.0 %RH</p> 	

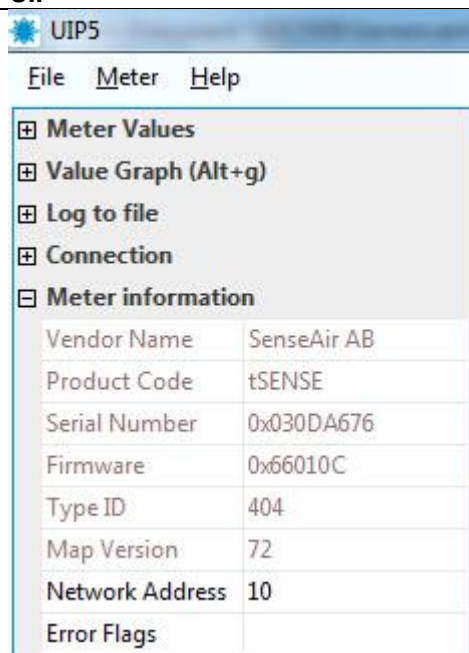

Meter settings  
Meter information

<p><b>1</b></p> <table border="1"> <tr> <td>CO<sub>2</sub></td> <td>429ppm</td> </tr> <tr> <td>Temperature</td> <td>23.1°C</td> </tr> <tr> <td>Humidity</td> <td>21%RH</td> </tr> <tr> <td></td> <td></td> </tr> </table> 	CO <sub>2</sub>	429ppm	Temperature	23.1°C	Humidity	21%RH			<p><b>2</b></p> <table border="1"> <tr> <td>CO<sub>2</sub></td> <td>Screen</td> </tr> <tr> <td>Temperature</td> <td>Settings</td> </tr> <tr> <td>Humidity</td> <td></td> </tr> <tr> <td></td> <td>«</td> </tr> </table> 	CO <sub>2</sub>	Screen	Temperature	Settings	Humidity			«	<p><b>3</b></p> <table border="1"> <tr> <td>Enter PIN</td> <td colspan="2">2001</td> </tr> <tr> <td></td> <td>2</td> <td>3</td> </tr> <tr> <td></td> <td>5</td> <td>6</td> </tr> <tr> <td></td> <td>8</td> <td>9</td> </tr> <tr> <td>Del</td> <td>0</td> <td>«</td> </tr> </table> 	Enter PIN	2001			2	3		5	6		8	9	Del	0	«	<p><b>4</b></p> <table border="1"> <tr> <td>Meter</td> <td></td> </tr> <tr> <td>Measurements</td> <td></td> </tr> <tr> <td>Outputs</td> <td></td> </tr> <tr> <td>Misc</td> <td>«</td> </tr> </table> 	Meter		Measurements		Outputs		Misc	«
CO <sub>2</sub>	429ppm																																									
Temperature	23.1°C																																									
Humidity	21%RH																																									
CO <sub>2</sub>	Screen																																									
Temperature	Settings																																									
Humidity																																										
	«																																									
Enter PIN	2001																																									
	2	3																																								
	5	6																																								
	8	9																																								
Del	0	«																																								
Meter																																										
Measurements																																										
Outputs																																										
Misc	«																																									
<p><b>5</b></p> <table border="1"> <tr> <td>Meter info</td> <td>RS-485</td> </tr> <tr> <td>PIN1</td> <td>PIN2</td> </tr> <tr> <td>Reset</td> <td></td> </tr> <tr> <td></td> <td>«</td> </tr> </table> 	Meter info	RS-485	PIN1	PIN2	Reset			«	<p><b>6</b></p> <table border="1"> <tr> <td colspan="2">Meter information</td> </tr> <tr> <td>Meter status</td> <td>0x0</td> </tr> <tr> <td>Version</td> <td>1.06</td> </tr> <tr> <td>Serial Number</td> <td>0x30DA676</td> </tr> <tr> <td>Type ID</td> <td>404</td> </tr> <tr> <td>Map Version</td> <td>72</td> </tr> <tr> <td></td> <td>«</td> </tr> </table>	Meter information		Meter status	0x0	Version	1.06	Serial Number	0x30DA676	Type ID	404	Map Version	72		«	<p><b>UIP</b></p> 																		
Meter info	RS-485																																									
PIN1	PIN2																																									
Reset																																										
	«																																									
Meter information																																										
Meter status	0x0																																									
Version	1.06																																									
Serial Number	0x30DA676																																									
Type ID	404																																									
Map Version	72																																									
	«																																									

## Temperature unit (°C/°F)







	<b>5</b>	<b>6</b>	<b>7</b>
Meter Measurement Outputs Misc	CO2 429ppm Temperature 23.1°C Humidity 21%RH	Temperature offset Temperature Unit	Temperature Units °F Celsius Fahrenheit
<b>1</b> Misc UIP5 Select property to edit Temperature Unit (C/F) Altitude(m) RS-485 Protocol (reset to activate new se) RS-485 Baudrate (reset to activate new se) RS-485 Parity (reset to activate new settin) RS-485 Stop bits (reset to activate new se)		<b>2</b> Property value C F Set Revert	

## Calibration options CO<sub>2</sub>

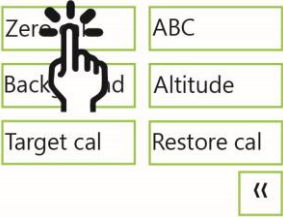

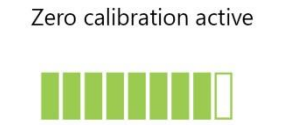

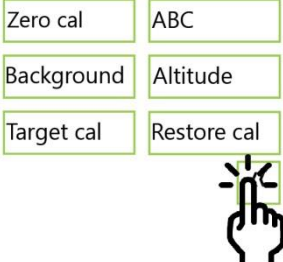
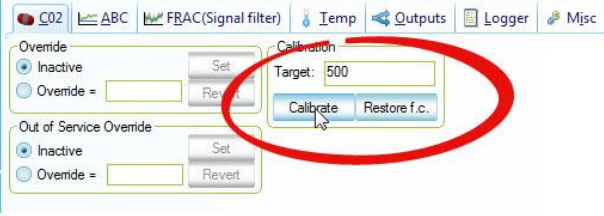
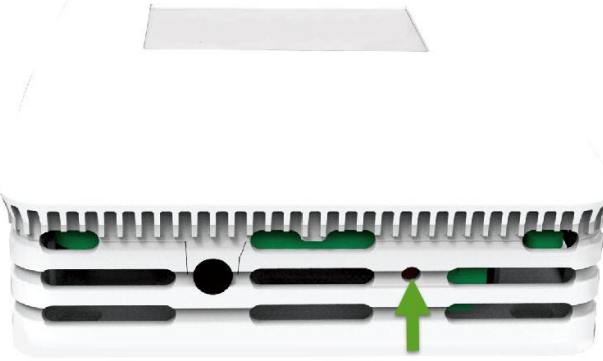



<b>4</b>	<b>5</b>
Meter Measurement Outputs Misc	CO2 429ppm Temperature 23.1°C Humidity 21%RH



## Zero cal/Background/Target cal

<p><b>6</b></p> 	<p><b>7</b></p> <p>Start zero calibration cycle?</p>  <p>Zero calibration in use 0ppm calibration target, calibration cycle takes ~5</p>	<p><b>8</b></p> <p>Zero calibration active</p> 	<p><b>9</b></p> <p>Verifying</p> 
<p><b>10</b></p> <p>Zero calibration succeeded</p>	<p><b>11</b></p> 	<p><b>UIP:</b> If reference meter shows e.g. CO<sub>2</sub>-value 500ppm set Target to 500</p> 	
<p><b>Background calibration button</b></p> <p><b>1</b> Press for 15s, until...</p>		<p><b>2</b> Green LED blinks twice</p>	
			

ABC  
Enable/Disable

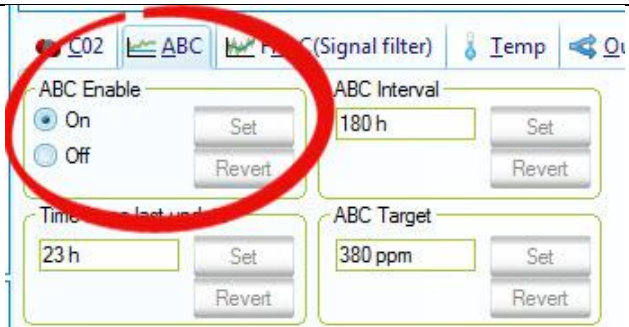
<p><b>1</b></p> <p>CO<sub>2</sub> 429ppm Temperature 23.1°C Humidity 21%RH</p> 	<p><b>2</b></p> <p>CO<sub>2</sub> Screen Temperature Set Humidity</p>  <p>«</p>	<p><b>3</b></p> <p>Enter PIN 2001</p> <table border="1"> <tr><td>2</td><td>3</td></tr> <tr><td>5</td><td>6</td></tr> <tr><td>8</td><td>9</td></tr> <tr><td>Del</td><td>0</td></tr> <tr><td></td><td>«</td></tr> </table> 	2	3	5	6	8	9	Del	0		«	<p><b>4</b></p> <p>Meter Measurements Outputs Misc</p>  <p>«</p>
2	3												
5	6												
8	9												
Del	0												
	«												
<p><b>5</b></p> <p>CO<sub>2</sub> 429ppm Temp 23.1°C Humidity 21%RH</p>  <p>«</p>	<p><b>6</b></p> <p>Zero cal ABC Background Altitude Target cal Restore cal</p>  <p>«</p>	<p><b>7</b></p> <p>ABC Inactive ABC period 180hours ABC target 380ppm</p>  <p>«</p>	<p><b>8</b></p> <p>ABC Active Enable Disable Save new ABC state? No</p>  <p>«</p>										
<p><b>9</b> Save</p> <p>ABC Active Enable Disable Save new ABC state? No</p> 	<p><b>UIP</b></p> 												

ABC period (ABC target/Altitude (msl)/Restore cal)

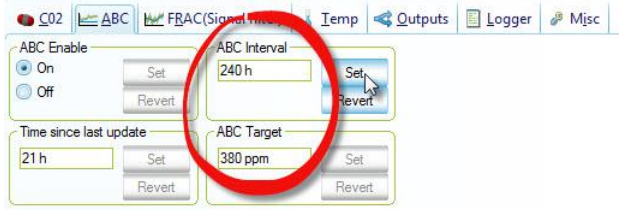
<p><b>5</b></p> <p>CO2 429ppm          Temperature 23.1°C          Humidity 21%RH</p> <p>«</p>	<p><b>6</b></p> <p>Zero cal ABC          Background Altitude          Target cal Restore cal</p> <p>«</p>	<p><b>7</b></p> <p>ABC Inactive          ABC period 180hours          ABC target 380ppm</p> <p>«</p>	<p><b>8</b></p> <p>ABC period 180 hours          - +          Save new ABC period?          Yes No</p> <p>«</p>
<p><b>9</b></p> <p>ABC period 240 hours          - +          Save new ABC period?          Yes</p> <p>«</p>	<p><b>10</b> 180, 181, 240hours</p> <p>ABC period 240 hours          - +          Save new ABC period?          No</p> <p>«</p>	<p><b>11</b> Save</p> <p>Saving ABC period</p> <p>██████████</p>	<p><b>12</b></p> <p>Verifying</p> <p>██████████</p>
<p><b>13</b></p> <p>ABC period set to 240 hours</p>	<p><b>1 4</b></p> <p>Zero cal ABC          Background Altitude          Target cal Restore cal</p> <p>«</p>	<p><b>UIP</b></p> 	

Temperature/Humidity Offset

<p><b>5</b></p> <p>CO2 429ppm          Temperature 23.1°C          Humidity 21%RH</p> <p>«</p>	<p><b>6</b></p> <p>Temperature offset          Temperature offset</p> <p>«</p>	<p><b>7</b> 0.0..-0.1...-2.5°C</p> <p>Temperature offset -2.5°C</p> <p>+ -</p> <p>«</p>	<p>Temperature offset -2.5°C</p> <p>- +</p> <p>«</p>
--	--	---	--

## Automatic system test

A full system test is executed automatically at every power-up. Sensor probes are checked constantly during operation against failure by checking valid dynamic measurement ranges.

System checks returns error bytes to RAM. Error codes are available by connecting the sensors to a PC with a special USB cable (art.no. 00-0-0070) connected (see fig. 2). Error codes are shown in the display at "Meter status" and in software UIP (version 5 or higher).

<p><b>1</b></p>	<p><b>2</b></p>	<p><b>3</b></p>	<p><b>4</b></p>
<p><b>5</b></p>	<p><b>6</b></p>	<p><b>UIP</b></p>	

## Error codes and action plans

Error symbol (a wrench appears when one or several error codes are active)

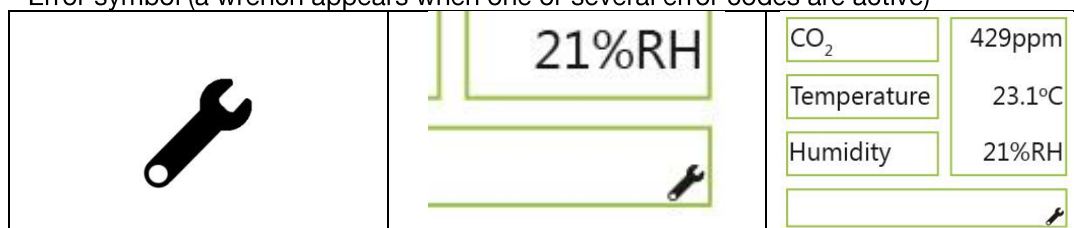

Bit #	Error code	Error description	Suggested action
0	CO <sub>2</sub> sensor Com. error	No ability to communicate with CO <sub>2</sub> sensor module.	Try to restart sensor by power OFF - power ON. Contact local distributor.
1	CO <sub>2</sub> sensor CO <sub>2</sub> measure error	CO <sub>2</sub> measurement error.	Try Background calibration ("Calibration options CO <sub>2</sub> " p.16). Contact local distributor. <i>See Note 1!</i>
2	T sensor T measure error	Temp measurement error.	Try to restart sensor by power OFF - power ON.  Contact local distributor.
3	RH/T sensor com error	No ability to communicate with RH/T sensor module.	
4	RH/T sensor RH measure error	RH measurement error.	
5	RH/T sensor T measure error	Temp measurement error, sensor will use CO <sub>2</sub> sensor temperature if RH/T Temperature is unavailable. S_Temp will be set to NTC_Temp.	
6			
7			
8	Output config. error	Error in output configuration. Output is still updated, i.e. can be 0-10V	Check connections and loads of outputs. Check detailed settings and configuration with UIP software version 5 or higher.  Contact local distributor.
9	Memory error	One or several bytes of sensors parameter memory (settings) are corrupt	Try to restart sensor by power OFF/ON Contact local distributor.

Table 2: Error codes and action plans.

Note 1. Any probe is out of range. It occurs during over exposure of CO<sub>2</sub> sensor, in which case the error code will automatically reset when the measurement values return to normal. It could also indicate the need of zero point calibration. If the CO<sub>2</sub> readings are normal, and still the error code remains, the temperature sensor can be defect or the connections to it are broken.

If several errors are detected at the same time, different error code numbers will be added together into one single error code!

Sensor accuracy is defined at continuous operation (at least three (3) weeks after installation).

# UIP Logger

## Alternative 1

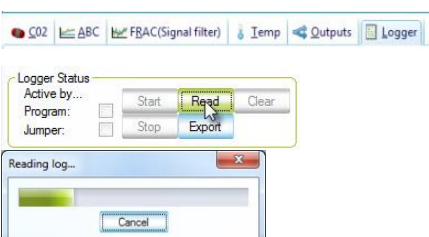
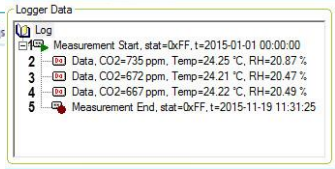
<p><b>1</b> Start to Read Log Data from sensor</p>	<p><b>2</b> Records for compatibility between UIP and other sensor types. <b>NOTE!</b> Sensor has no timer.</p>
	 <p>1 Measurement Start. Record added by UIP for compatibility between UIP and other sensor types. Status = dummy value Timestamp = dummy value 2 Oldest data record in log, average values for 15 minutes 3 Average values for 15 minutes after point 2 4 Measurement end. Record added to readout by UIP Status = dummy value Timestamp = time log was read from sensor</p>



### NOTE!

The log consists of 15 min averages, 672 (4 x 24h x 7d) data points for each value.

tSENSE has no real-time clock (no timestamps in the sensors log). If the sensor has not been powered on continuously, time between data points can be much longer than 15 minutes. Timestamps in UIP log file are added by UIP.

Chart 24h and Week (7 days) plots use data from the same log.

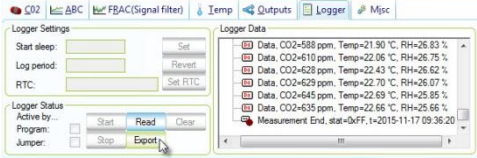
## Export Logger Data

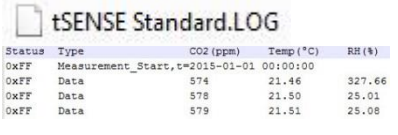
<p><b>1</b></p>	<p><b>2</b> Options</p>																										
		 <table border="1"> <thead> <tr> <th>Status</th> <th>Type</th> <th>CO2 (ppm)</th> <th>Temp (°C)</th> <th>RH (%)</th> </tr> </thead> <tbody> <tr> <td>0xFF</td> <td>Measurement_Start, t=2015-01-01 00:00:00</td> <td></td> <td></td> <td></td> </tr> <tr> <td>0xFF</td> <td>Data</td> <td>574</td> <td>21.46</td> <td>327.66</td> </tr> <tr> <td>0xFF</td> <td>Data</td> <td>578</td> <td>21.50</td> <td>25.01</td> </tr> <tr> <td>0xFF</td> <td>Data</td> <td>579</td> <td>21.51</td> <td>25.08</td> </tr> </tbody> </table>	Status	Type	CO2 (ppm)	Temp (°C)	RH (%)	0xFF	Measurement_Start, t=2015-01-01 00:00:00				0xFF	Data	574	21.46	327.66	0xFF	Data	578	21.50	25.01	0xFF	Data	579	21.51	25.08
Status	Type	CO2 (ppm)	Temp (°C)	RH (%)																							
0xFF	Measurement_Start, t=2015-01-01 00:00:00																										
0xFF	Data	574	21.46	327.66																							
0xFF	Data	578	21.50	25.01																							
0xFF	Data	579	21.51	25.08																							





## Alternative 2

### Log to file

**1** Start log to file on PC

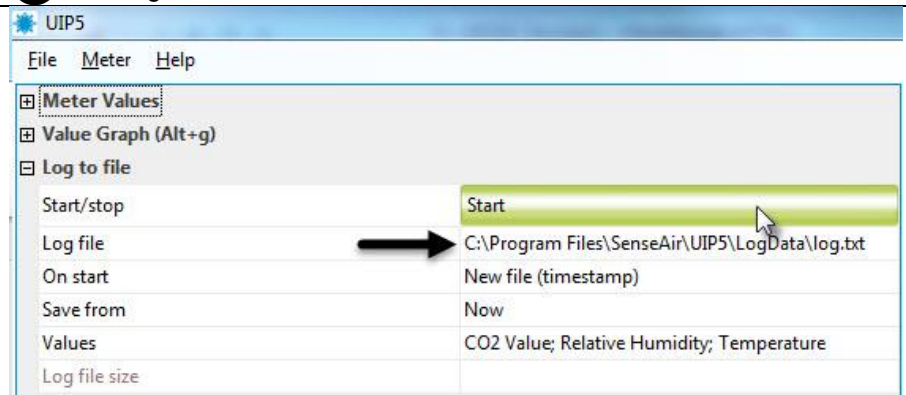

The screenshot shows the UIP5 application window with the 'Log to file' menu open. The 'Start' option is highlighted in green. An arrow points from the 'Log file' row to the path 'C:\Program Files\SenseAir\UIP5\LogData\log.txt'.

**2**

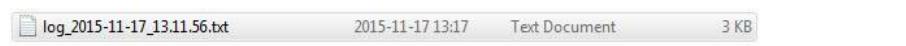

The screenshot shows a file explorer window displaying a log file named 'log\_2015-11-17\_13.11.56.txt' with a size of 3 KB.





**3**

Time	Offset ÅmsÅ	CO2 Value ÅppmÅ	Relative Humidity Å%Å
2015-11-17 13:11:58	9149974	685.00 24.36	24.36
2015-11-17 13:12:03	9154919	685.00 24.31	24.36



The screenshot shows a table of log data with columns for Time, Offset ÅmsÅ, CO2 Value ÅppmÅ, and Relative Humidity Å%Å. The data rows show values for 2015-11-17 at 13:11:58 and 13:12:03.





# PIN codes

<b>1</b>	<b>2</b>	<b>3</b>	<b>4</b>																																		
<table border="1"> <tr><td>CO<sub>2</sub></td><td>429ppm</td></tr> <tr><td>Temperature</td><td>23.1°C</td></tr> <tr><td>Humidity</td><td>21%RH</td></tr> <tr><td></td><td></td></tr> </table> 	CO <sub>2</sub>	429ppm	Temperature	23.1°C	Humidity	21%RH			<table border="1"> <tr><td>CO<sub>2</sub></td><td>Screen</td></tr> <tr><td>Temperature</td><td>Settings</td></tr> <tr><td>Humidity</td><td></td></tr> <tr><td></td><td>«</td></tr> </table> 	CO <sub>2</sub>	Screen	Temperature	Settings	Humidity			«	<table border="1"> <tr><td>Enter PIN</td><td>2001</td></tr> <tr><td></td><td>2 3</td></tr> <tr><td></td><td>5 6</td></tr> <tr><td></td><td>8 9</td></tr> <tr><td>Del</td><td>0 «</td></tr> </table> 	Enter PIN	2001		2 3		5 6		8 9	Del	0 «	<table border="1"> <tr><td>Meter</td><td></td></tr> <tr><td>Measurements</td><td></td></tr> <tr><td>Outputs</td><td></td></tr> <tr><td>Misc</td><td>«</td></tr> </table> 	Meter		Measurements		Outputs		Misc	«
CO <sub>2</sub>	429ppm																																				
Temperature	23.1°C																																				
Humidity	21%RH																																				
CO <sub>2</sub>	Screen																																				
Temperature	Settings																																				
Humidity																																					
	«																																				
Enter PIN	2001																																				
	2 3																																				
	5 6																																				
	8 9																																				
Del	0 «																																				
Meter																																					
Measurements																																					
Outputs																																					
Misc	«																																				



## Change PIN code for access to display settings (PIN1)

<b>5</b> PIN1	<b>6</b> (Default 0000)	<b>7</b>																																																							
<table border="1"> <tr><td>Meter info</td><td>RS-485</td></tr> <tr><td>PIN1</td><td>PIN2</td></tr> <tr><td>Reset</td><td></td></tr> <tr><td></td><td>«</td></tr> </table> 	Meter info	RS-485	PIN1	PIN2	Reset			«	<table border="1"> <tr><td colspan="4">Pin code for access to display settings</td></tr> <tr><td>PIN</td><td>2</td><td>4</td><td>9</td><td>1</td></tr> <tr><td>On</td><td>+</td><td>+</td><td>+</td><td>+</td></tr> <tr><td></td><td>-</td><td>-</td><td>-</td><td>-</td></tr> <tr><td>PIN On/Off</td><td>Save</td><td colspan="2">«</td></tr> </table> 	Pin code for access to display settings				PIN	2	4	9	1	On	+	+	+	+		-	-	-	-	PIN On/Off	Save	«		<table border="1"> <tr><td colspan="4">Pin code for access to display settings</td></tr> <tr><td>PIN</td><td>2</td><td>4</td><td>9</td><td>1</td></tr> <tr><td>On</td><td>+</td><td>+</td><td>+</td><td>+</td></tr> <tr><td></td><td>-</td><td>-</td><td>-</td><td>-</td></tr> <tr><td>PIN On/Off</td><td></td><td></td><td></td><td>«</td></tr> </table> 	Pin code for access to display settings				PIN	2	4	9	1	On	+	+	+	+		-	-	-	-	PIN On/Off				«
Meter info	RS-485																																																								
PIN1	PIN2																																																								
Reset																																																									
	«																																																								
Pin code for access to display settings																																																									
PIN	2	4	9	1																																																					
On	+	+	+	+																																																					
	-	-	-	-																																																					
PIN On/Off	Save	«																																																							
Pin code for access to display settings																																																									
PIN	2	4	9	1																																																					
On	+	+	+	+																																																					
	-	-	-	-																																																					
PIN On/Off				«																																																					

## Toggle PIN1 On/Off

<b>6</b>	<b>7</b>																																															
<table border="1"> <tr><td colspan="4">Pin code for access to display settings</td></tr> <tr><td>PIN</td><td>0</td><td>0</td><td>0</td><td>0</td></tr> <tr><td>On</td><td>+</td><td>+</td><td>+</td><td>+</td></tr> <tr><td></td><td>-</td><td>-</td><td>-</td><td>-</td></tr> <tr><td>PIN On/Off</td><td>Save</td><td colspan="2">«</td></tr> </table> 	Pin code for access to display settings				PIN	0	0	0	0	On	+	+	+	+		-	-	-	-	PIN On/Off	Save	«		<table border="1"> <tr><td colspan="4">Pin code for access to display settings</td></tr> <tr><td>PIN</td><td>1</td><td>0</td><td>0</td><td>0</td></tr> <tr><td>On</td><td>+</td><td>+</td><td>+</td><td>+</td></tr> <tr><td></td><td>-</td><td>-</td><td>-</td><td>-</td></tr> <tr><td>PIN On/Off</td><td></td><td></td><td></td><td>«</td></tr> </table> 	Pin code for access to display settings				PIN	1	0	0	0	On	+	+	+	+		-	-	-	-	PIN On/Off				«
Pin code for access to display settings																																																
PIN	0	0	0	0																																												
On	+	+	+	+																																												
	-	-	-	-																																												
PIN On/Off	Save	«																																														
Pin code for access to display settings																																																
PIN	1	0	0	0																																												
On	+	+	+	+																																												
	-	-	-	-																																												
PIN On/Off				«																																												

## Change PIN code for access to meter settings (PIN2)

<b>5</b> PIN2	<b>6</b> Create PIN2 Code	<b>7</b> Save																																																							
<table border="1"> <tr><td>Meter info</td><td>RS-485</td></tr> <tr><td>PIN1</td><td>PIN2</td></tr> <tr><td>Reset</td><td></td></tr> <tr><td></td><td>«</td></tr> </table> 	Meter info	RS-485	PIN1	PIN2	Reset			«	<table border="1"> <tr><td colspan="4">Pin code for access to settings</td></tr> <tr><td>PIN</td><td>1</td><td>0</td><td>0</td><td>0</td></tr> <tr><td></td><td>+</td><td>+</td><td>+</td><td></td></tr> <tr><td></td><td>-</td><td>-</td><td>-</td><td></td></tr> <tr><td></td><td>Save</td><td colspan="2">«</td></tr> </table> 	Pin code for access to settings				PIN	1	0	0	0		+	+	+			-	-	-			Save	«		<table border="1"> <tr><td colspan="4">Pin code for access to display settings</td></tr> <tr><td>PIN</td><td>1</td><td>0</td><td>0</td><td>0</td></tr> <tr><td>On</td><td>+</td><td>+</td><td>+</td><td>+</td></tr> <tr><td></td><td>-</td><td>-</td><td>-</td><td>-</td></tr> <tr><td></td><td></td><td></td><td></td><td>«</td></tr> </table> 	Pin code for access to display settings				PIN	1	0	0	0	On	+	+	+	+		-	-	-	-					«
Meter info	RS-485																																																								
PIN1	PIN2																																																								
Reset																																																									
	«																																																								
Pin code for access to settings																																																									
PIN	1	0	0	0																																																					
	+	+	+																																																						
	-	-	-																																																						
	Save	«																																																							
Pin code for access to display settings																																																									
PIN	1	0	0	0																																																					
On	+	+	+	+																																																					
	-	-	-	-																																																					
				«																																																					

## Maintenance

tSENSE (Disp) is maintenance free. Internal self-adjusting calibration (ABC) function takes care of normal long term drift. To secure highest accuracy, a time interval of five years is recommended between CO<sub>2</sub> calibrations, unless some special situations have occurred.

### **Cleaning** (exterior only):

Use mild detergent (no harsh chemicals) and wipe dry with a dry cloth.

Software can be downloaded free at [www.senseair.com](http://www.senseair.com).

USB-cable and zero calibration kit can be ordered from Senseair.

Check can be done on site without interfering with ventilation system.



[www.senseair.com](http://www.senseair.com).